

MSP 210C



User Manual

- Manual #: RGB-RD-UM-M210C E001
- Revision: V1.0



MSP 210C-User Manual

Thank you for choosing our products!

In order to allow you to learn how to use the Mini Converter quickly, we bring you the detailed user Manual. You can read the introduction and directions before using the video processor, please read all the information we provide carefully to use our products correctly.

Copyright

©2015 All rights are reserved by RGBLINK.

This document is done independently by Xiamen RGBlink Science & Technology Co.,LTD. No part can be copied, reproduced or translated without permission.

Notice

RGBlink provides this manual “as is” without warranty of any kind, no matter expressed or implied, including but not limited to the implied warranties or merchantability and fitness for a particular purpose. RGBlink may make improvements or changes to the products and the programs described in this publication at any time without notice.

This publication would contain technical inaccuracies or typographical errors. Changes are periodically made to the information in this publication; these changes are incorporated in new editions of this publication.

Federal Communications Commission

(FCC) Statement

This equipment has been tested and found to comply with the limits for a class A digital device, pursuant to Part 15 of the FCC rules. These limits are designed to provide reasonable protection against harmful interference when the equipment is operated in a commercial environment. This equipment generates, uses and radiates radio frequency energy and, if not installed or used in accordance with the instruction manual, may cause harmful interference to radio communications. Operation of this equipment in a residential area may cause harmful interference, in which case the user will be responsible for correcting any interference.

Guarantee and Compensation

RGBlink provides a guarantee related to perfect manufacturing as part of the legally stipulated terms of guarantee. On receipt, the purchaser must immediately inspect all delivered goods for damage incurred during transportation, as well as for material and manufacturing faults. Please complain to RGBlink by written notice.

The period of guarantee begins from the date of transfer of risks, in the case of special systems and software on the date of commissioning, at latest 30 days after the transfer of risks. In the event of justified notice of compliant, RGBlink can repair the fault or provide a replacement at its own discretion within an appropriate period. If this measure proves to be impossible or unsuccessful, the purchaser can demand a reduction in the purchase price or cancellation of the contract. All other claims, in particular those relating to compensation for direct or indirect damage, and also damage attributed to the operation of software as well as to other service provided by RGBlink, being a component of the system or independent service, will be deemed invalid provided the damage is not proven to be attributed to the absence of properties guaranteed in writing or due to the intent or gross negligence or part of RGBlink.

If the purchaser or a third party carries out modifications or repairs on goods delivered by RGBlink, or if the goods are handled incorrectly, in particular if the systems are commissioned operated incorrectly or if, after the transfer of risks, the goods are subject to influences not agreed upon in the contract, all guarantee claims of the purchaser will be rendered invalid. Not included in the guarantee coverage are system failures which are attributed to programs or special electronic circuitry provided by the purchaser, e.g. interfaces. Normal wear as well as normal maintenance are not subject to the guarantee provided by RGBlink either.

The environmental conditions as well as the servicing and maintenance regulations specified in this manual must be complied with the customer.

Trademark

Brand and product names mentioned in this manual may be trademarks, registered trademarks or copyrights of their respective holders. All brand and product names mentioned in this manual serve as comments or examples and are not to be understood as advertising for the products or their manufactures.

Company Address

RGBlink Xiamen RGBlink Science & Technology Co., Ltd.

Headquarter: S603~604 Wei ye Building Torch Hi-Tech Industrial Development Zone Xiamen, Fujian Province, P.R.C

Shenzhen office: Floor 11, A1 Building, Baiwang R&D Building, Shahe West Road, Xili Town, Nanshan District, Shenzhen, Guangdong Province, P.R.C

Beijing office: Room 602, Building 7, CaiManJie, No.67 Chao yang Road, Chao yang District, Beijing, P.R.C

Shanghai office: Building 3, 1358 Nong, Tong pu Road, Shanghai, P.R.C

- **Tel:** +86-592-5771197
- **Fax:** +86-592-5771202
- **Customer Hotline:** 4008-592-315
- **Websites:**
 - ~ <http://www.rgblink.com>
 - ~ <http://www.rgblink.cn>
- **E-mail:** sales@rgblink.com

Operators Safety Summary

The general safety information in this summary is for operating personnel.

Do Not Remove Covers or Panels

There are no user-serviceable parts within the unit. Removal of the top cover will expose dangerous voltages. To avoid personal injury, do not remove the top cover. Do not operate the unit without the cover installed.

Power Source

This product is intended to operate from a power source that will not apply more than 230 volts rms between the supply conductors or between both supply conductor and ground. A protective ground connection by way of grounding conductor in the power cord is essential for safe operation.

Grounding the Product

This product is grounded through the grounding conductor of the power cord. To avoid electrical shock, plug the power cord into a properly wired receptacle before connecting to the product input or output terminals. A protective-ground connection by way of the grounding conductor in the power cord is essential for safe operation.

Use the Proper Power Cord

Use only the power cord and connector specified for your product. Use only a power cord that is in good condition. Refer cord and connector changes to qualified service personnel.

Use the Proper Fuse

To avoid fire hazard, use only the fuse having identical type, voltage rating, and current rating characteristics. Refer fuse replacement to qualified service personnel.

Do Not Operate in Explosive

Atmospheres

To avoid explosion, do not operate this product in an explosive atmosphere.

Terms in This Manual and Equipment Marking



WARNING

Highlight an operating procedure, practice, condition, statement, etc, which, if not strictly observed, could result in injury or death of personnel.

Note

Highlights an essential operating procedure, condition or statement.
--



CAUTION

The exclamation point within an equilateral triangle is intended to alert the user to the presence of important operating and maintenance (servicing) instructions in the literature accompanying the appliance.

Amendment Records

The table below lists the changes to the Mini Converter User Manual.

Format	Time	ECO#	Description	Principal
V1.0	2014-01-08	0001#	Release	Vira

CONTENT

CONTENT	8
1. Brief Introduction.....	10
Chapter Structure	11
How to Use the Manual	12
Term and Definitions	13
System Overview	19
Application Questions	20
2. Hardware Orientation	21
In This Chapter	21
Interface Description	22
INPUT Interface.....	22
1: CVBS Input.....	22
2.3: Audio Input Interface.....	22
4.5: Indicator	22
OUTPUT and Other Interface	23
3: SDI Output Interface	23
5: USB Interface.....	23
1: Power	23
2.4.6: Indicator.....	23
Dial Switch	24

1. Dial Switch	24
3. Functional Description	25
Functional Description	25
Functional Description Block Diagram.....	25
4. Dial Switch Function	26
Functional Description Block Diagram.....	26
Instructions.....	27
5. Communication Software Guideline.....	30
Running Software.....	30
Use	30
Audio	30
Version.....	31
Output Format	31
[Video Processor] Options.....	31
Language	31
Admin.....	31
Help	32
A. Specification	34
B. Contact Information.....	35

1. Brief Introduction

This chapter is designed to introduce you to the MSP 210C User Manual.
Areas to be covered are:

- Chapter Structure
- How to Use The Manual
- Terms and Definitions
- System Overview
- Application Questions

1. Brief Introduction

Chapter Structure

Chapter Structure

The following chapters provide instructions for all aspects of MSP 210C operations.

Chapter 1 [Brief Introduction](#)

Chapter 2 [Hardware Orientation](#)

Chapter 3 [Functional Description](#)

Chapter 4 [Dial Switch Function](#)

Chapter 5 [Communication Software Guideline](#)

Appendix A [Specification](#)

Appendix B [Contact Information](#)

1. Brief Introduction

How to Use The Manual

How to Use the Manual

Followings are important tips for streamlining your use of this User Manual in its electronic “PDF” form.

Navigation

Use Acrobat Reader’s “bookmarks” to navigate to the desired location. All chapter files have the same bookmark structure for instant navigation to any section. Please note:



- Extensive hyperlinks are provided within the chapters.
- Use Acrobat’s “**Go to Previous View**” and “**Return to next View**” buttons to trace your complete navigational path.



- Use the “**Previous Page**” and “**Next Page**” buttons to go to the previous or next page within a file.
- Use Acrobat’s extensive search capabilities, such as the “**Find**” tool and “**Search Index**” tool to perform comprehensive searches as required.

Table of Contents and Index

Use the Table of Contents bookmarks to navigate a desired topic. Click any item to instantly jump to that section of the guide. You can also use the **Index** to jump to specific topics within a chapter. Each page number in the **Index** is a hyperlink.

Should you have any questions regarding the installation or operation of MSP 210C, please consult with the factory. Refer to Appendix B on page 35 for “Contact Information”.

1. Brief Introduction

Terms and Definitions

Term and Definitions

The following terms and definitions are used throughout this guide.

- **“ASCII”**: American Standard for Information Interchange. The standard code consisting of 7-bit coded characters (8 bits including parity check) used to exchange information between data processing systems, data communication systems, and associated equipment. The ASCII set contains control characters and graphic characters.
- **“Aspect ratio”**: The relationship of the horizontal dimension to the vertical dimension of an image. In viewing screens, standard TV is 4:3, or 1.33:1; HDTV is 16:9, or 1.78:1. Sometimes the “:1” is implicit, making TV = 1.33 and HDTV = 1.78.
- **“AV”**: Audio visual or audio video.
- A **“Background”** is an unscaled source, typically originating from a computer. A background source appears at the system’s lowest priority — visually in back of all other sources.
- **“Baudrate”**: Named of J.M.E. Baudot, the inventor of the Baudot telegraph code. The number of the electrical oscillations per second, called baud rate. Related to, but not the same as, transfer rate in bits per second (bps).
- **“Blackburst”**: The video waveform without the video elements. It includes the vertical sync, horizontal sync, and the chroma burst information. Blackburst is used to synchronize video equipment to align the video output. One signal is normally used to set up an entire video system or facility. Sometimes it is called House sync.
- **“BNC”**: Bayonet Neill-Concelman. A cable connector used extensively in television and named for its inventors. A cylindrical bayonet connector that operates with a twist-locking motion. To make the connection, align the two curved grooves in the collar of the male connector with the two projections on the outside of the female collar, push, and twist. This allows the connector to lock into place without tools.
- **“Brightness”**: Usually refers to the amount or intensity of video light produced on a screen without regard to color. Sometimes called “black level.”
- **“CAT 5”**: Category 5. Describes the network cabling standard that consists of four unshielded twisted pairs of copper wire terminated by RJ-45 connectors. CAT 5 cabling supports data rates up to 100 Mbps. CAT 5 is based on the EIA/TIA 568 Commercial Building Telecommunications Wiring Standard.
- **“Color bars”**: A standard test pattern of several basic colors (white, yellow, cyan, green, magenta, red, blue, and black) as a reference for system alignment and testing. In NTSC video, the most commonly

1. Brief Introduction

Terms and Definitions

- Used color bars are the SMPTE standard color bars. In PAL video, the most commonly used color bars are eight full field bars. In the computer, the most commonly used color bars are two rows of reversed color bars.
- **“Color burst”**: In color TV systems, a burst of sub carrier frequency located on the back porch of the composite video signal. This serves as a color synchronizing signal to establish a frequency and phase reference for the chroma signal. Color burst is 3.58 MHz for NTSC and 4.43 MHz for PAL.
- **“Color temperature”**: The color quality, expressed in degrees Kelvin (K), of a light source. The higher the color temperature, the bluer the light. The lower the temperature, the redder the light. Benchmark color temperature for the A/V industry includes 5000°K, 6500°K, and 9000°K.
- **“Contrast ratio”**: The ratio of the high light output level divided by the low light output level. In theory, the contrast ratio of the television system should be at least 100:1, if not 300:1. In reality, there are several limitations. In the CRT, light from adjacent elements contaminate the area of each element. Room ambient light will contaminate the light emitted from the CRT. Well-controlled viewing conditions should yield a practical contrast ratio of 30:1 to 50:1.
- **“DVI”**: Digital Visual Interface. The digital video connectivity standard that was developed by DDWG (Digital Display Work Group). This connection standard offers two different connectors: one with 24 pins that handles digital video signals only, and one with 29 pins that handles both digital and analog video.
- **“EDID”**: Extended Display Identification Data – EDID is a data structure used to communicate video display information, including native resolution and vertical interval refresh rate requirements, to a source device. The source device will then output the optimal video format for the display based on the provided EDID data, ensuring proper video image quality. This communication takes place over the DDC – Display Data Channel.
- **“Ethernet”**: A Local Area Network (LAN) standard officially known as IEEE 802.3. Ethernet and other LAN technologies are used for interconnecting computers, printers, workstations, terminals, servers, etc. within the same building or campus. Ethernet operates over twisted pair and over coaxial cable at speeds starting at 10Mbps. For LAN interconnectivity, Ethernet is physical link and data link protocol reflecting the two lowest layers of the OSI Reference Model.
- **“Frame”**: In interlaced video, a frame is one complete picture. A video frame is made up of two fields, or two sets of interlaced lines. In a film, a frame is one still picture of a series that makes up a motion picture.

1. Brief Introduction

Terms and Definitions

- **“Gamma”**: The light output of a CRT is not linear with respect to the voltage input. The difference between what you should have and what is actually output is known as gamma.
- **“HDMI” - High – Definition Multimedia Interface**: An interface used primarily in consumer electronics for the transmission of uncompressed high definition video, up to 8 channels of audio, and control signals, over a single cable. HDMI is the de facto standard for HDTV displays, Blu-ray Disc players, and other HDTV electronics. Introduced in 2003, the HDMI specification has gone through several revisions.
- **“HDSDI”**: The high-definition version of SDI specified in SMPTE-292M. This signal standard transmits audio and video with 10 bit depth and 4:2:2 color quantization over a single coaxial cable with a data rate of 1.485 Gbit/second. Multiple video resolutions exist including progressive 1280x720 and interlaced 1920x1080 resolutions. Up to 32 audio signals are carried in the ancillary data.
- **“JPEG” (Joint photographic Expects Group)**: Commonly used method of loss compression for photographic images using a discreet cosine transfer function. The degree of compression can be adjusted, allowing a selectable tradeoff between storage size and image quality. JPEG typically achieves 10:1 compression with little perceptible loss in image quality. Produces blocking artifacts.
- **“MPEG”**: Motion Picture Expect Group. A standard committee under the auspices of the International Standards Organization working on algorithm standards that allows digital compression, storage and transmission of moving image information such as motion video, CD-quality audio, and control data at CD-ROM bandwidth. The MPEG algorithm provides inter-frame compression of video images and can have an effective compression rate of 100:1 to 200:1.
- **“NTSC”**: The color video standard used in North America and some other parts of the world created by the National Television Standards Committee in the 1950s. A color signal must be compatible with black-and-white TV sets. NTSC utilizes an interlaced video signals, 525 lines of resolution with a refresh rate of 60 fields per second (60 Hz). Each frame is comprised of two fields of 262.5 lines each, running at an effective rate of 30 frames per second.
- **“Operator”**: Refers to the person who uses the system.
- **“PAL”**: Phase Alternate Line. A television standard in which the phase of the color carrier is alternated from line to line. It takes four full pictures (8 fields) for the color-to-horizontal phase relationship to return to the reference point. This alternation helps cancel out phase errors. For this reason, the hue control is not needed on a PAL TV set. PAL, in many transmission forms, is widely used in Western Europe,

1. Brief Introduction

Terms and Definitions

Australia, Africa, the Middle East, and Micronesia. PAL uses 625-line, 50-field (25 fps) composite color transmission system.

- **“PIP”**: Picture-in-Picture. A small picture within a larger picture created by scaling down one of the images to make it smaller. Each picture requires a separate video source such as a camera, VCR, or computer. Other forms of PIP displays include Picture-by-Picture (PBP) and Picture-with-Picture (PWP), which are commonly used with 16:9 aspect display devices. PBP and PWP image formats require a separate scaler for each video window.
- **“Polarity”**: The positive and negative orientation of a signal. Polarity usually refers to the direction or a level with respect to a reference (e.g. positive sync polarity means that sync occurs when the signal is going in the positive direction).
- **“RJ-45”**: Registered Jack-45. A connector similar to a telephone connector that holds up to eight wires used for connecting Ethernet devices.
- **“RS-232”**: An Electronic Industries Association (EIA) serial digital interface standard specifying the characteristics of the communication path between two devices using either DB-9 or DB-25 connectors. This standard is used for relatively short-range communication and does not specify balanced control lines. RS-232 is a serial control standard with a set number of conductors, data rate, word length, and type of connector to be used. The standard specifies component connection standards with regard to the computer interface. It is also called RS-232-C, which is the third version of the RS-232 standard, and is functionally identical to the CCITT V.24 standard.
- **“Saturation”**: Chroma, chroma gain. The intensity of the color, or the extent to which a given color in any image is free from white. The less white in a color, the truer the color or the greater its saturation. On a display device, the color control adjusts the saturation. Not to be confused with the brightness, saturation is the amount of pigment in a color, and not the intensity. Low saturation is like adding white to the color. For example, a low-saturated red looks pink.
- **“Scaling”**: A conversion of a video or computer graphic signal from a starting resolution to a new resolution. Scaling from one resolution to another is typically done to optimize the signal for input to an image processor, transmission path or to improve its quality when presented on a particular display.
- **“SDI”**: Serial Digital Interface. The standard based on a 270 Mbps transfer rate. This is a 10-bit, scrambled, polarity independent interface with common scrambling for both component ITU-R 601 and composite digital video and four channels of (embedded) digital audio.
- **“Seamless Switching”**: A feature found on many video switchers. This

1. Brief Introduction

Terms and Definitions

feature causes the switcher to wait until the vertical interval to switch. This avoids a glitch (temporary scrambling) which normally is seen when switching between sources.

- **“SMPTE”**: Society of Motion Picture and Television Engineers. A global organization, based in the United States that sets standards for base band visual communications. This includes film as well as video and television standards.
- **“S-Video”**: A composite video signal separated into the luma (“Y” is for luma, or black and white information; brightness) and the chroma (“C” is an abbreviation for chroma, or color information).
- **“Sync”**: Synchronization. In video, sync is a means of controlling the timing of an event with respect to other events. This is accomplished with timing pulses to insure that each step in a process occurs at the correct time. For example, horizontal sync determines exactly when to begin each horizontal scan line. Vertical sync determines when the image is to be refreshed to start a new field or frame. There are many other types of sync in video system. (Also known as “sync signal” or “sync pulse.”)
- **“TCP/IP”**: Transmission Control Protocol/Internet Protocol. The communication protocol of the Internet. Computers and devices with direct access to the Internet are provided with a copy of the TCP/IP program to allow them to send and receive information in an understandable form.
- **“USB”**: Universal Serial Bus. USB was developed by seven PC and telecom industry leaders (Compaq, DEC, IBM, Intel, Microsoft, NEC, and Northern Telecom). The goal was easy plug-and-play expansion outside the box, requiring no additional circuit cards. Up to 127 external computer devices may be added through a USB hub, which may be conveniently located in a keyboard or monitor. USB devices can be attached or detached without removing computer power. The number of devices being designed for USB continues to grow, from keyboards, mice, and printers to scanners, digital cameras, and ZIP drives.
- **“VESA”**: Video Electronics Standards Association. A nonprofit number organization dedicated to facilitating and promoting personal computer graphics through improved standards for the benefit of the end-user. www.vesa.org
- **“VGA”**: Video Graphics Array. Introduced by IBM in 1987, VGA is an analog signal with TTL level separate horizontal and vertical sync. The video outputs to a 15-pin HD connector and has a horizontal scan frequency of 31.5 kHz and vertical frequency of 70 Hz (Mode 1, 2) and 60 Hz (Mode 3). The signal is non-interlaced in modes 1, 2, and 3 and interlaced when using the 8514/A card (35.5 kHz, 86 Hz) in mode 4. It

1. Brief Introduction

Terms and Definitions

has a pixel by line resolution of 640×480 with a color palette of 16 bits and 256,000 colors.

- **“YCrCb”**: Used to describe the color space for interlaced component video.
- **“YPbPr”**: Used to describe the color space for progressive-scan (non-interlaced) component video.

1. Brief Introduction

System Overview

System Overview

MSP 210C is the CVBS to SDI video converter, which can realize the switching from CVBS to 3G/HD/SD-SDI perfectly. It supports 1 CVBS input, 2 balanced analog audio input or 1 digital AES/EBU input, and 1SDI output. MSP 210C supports input resolution of SMPTE: 480i, 576i, and output resolution of SMPTE: 480i, 576i, 720p@50Hz, 720p@60Hz, 1080i@50Hz, 1080i@60Hz, 1080p@50Hz, 1080p@60Hz, also supports SCALE, left and right analog sound channel input, digital AES/EBU input, CVBS embedded audio input and mute function. It can adapt to multiple rates of SDI signal, including 3G-SDI, HD-SDI and SD- SDI. Easy operation. It is really the best bridge for CVBS to broadcasting SDI application!

1. Brief Introduction

Application Questions

Application Questions

RGBlink offers solutions to demand technical problems. Any application questions, or required further information, please contact with our Customer Support Engineers. Refer to Appendix B for contact details.

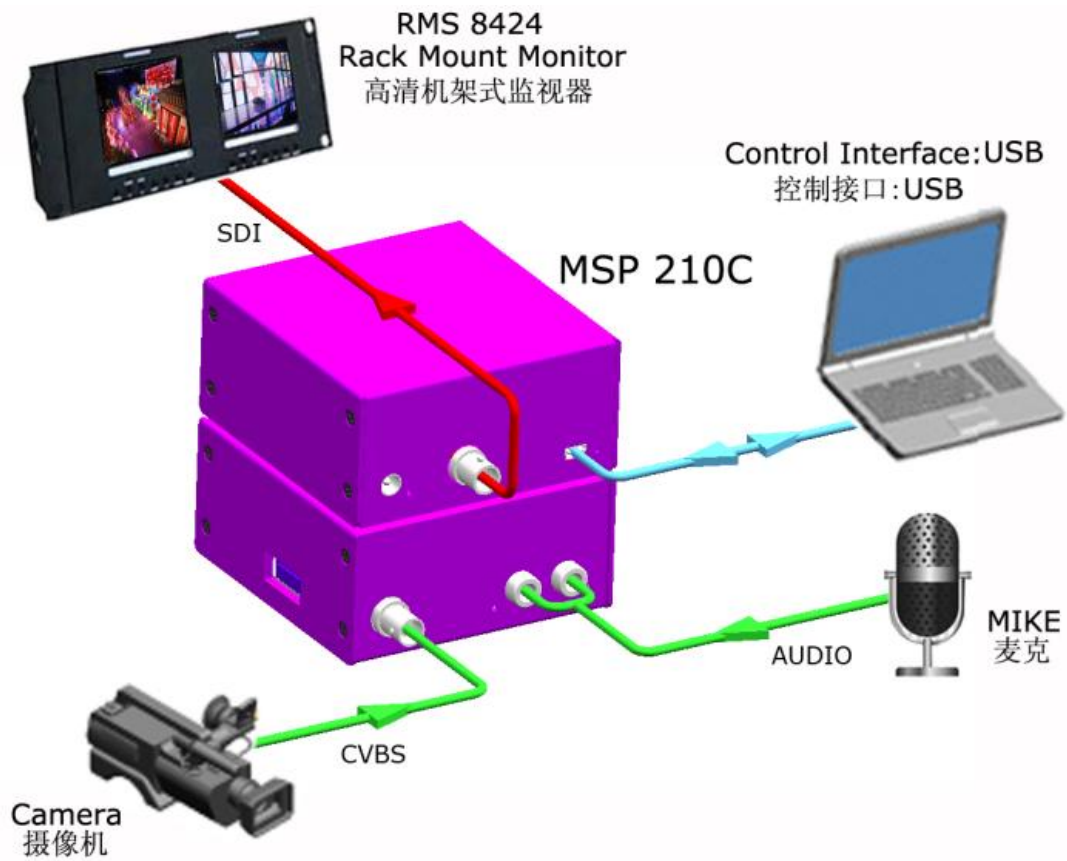

2. Hardware Orientation

In This Chapter

This chapter provides detailed information about the MSP 210C hardware. The following topics are discussed:

- [Interface Description](#)
- [Dial Switch](#)

2. Hardware Orientation

Interface Description

Interface Description

INPUT Interface

It includes 1 CVBS input, 2 balanced analog audio input or 1 digital AES/EBU input. The figure below illustrates the professional interface of MSP 210C.

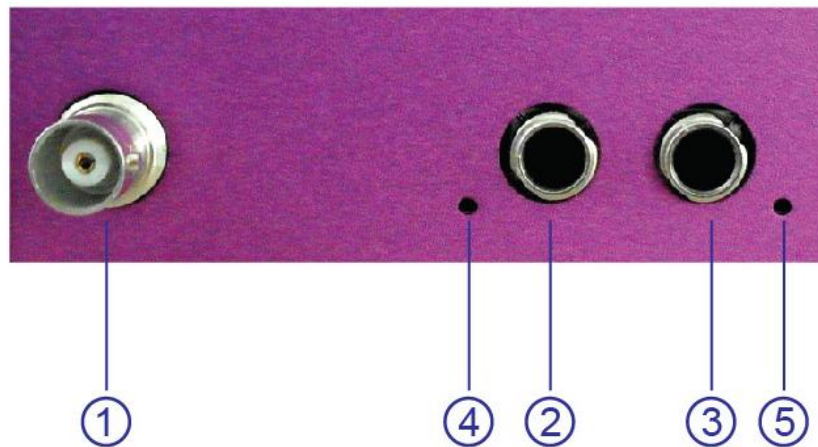

1: CVBS Input

CVBS input interface, input the video signal from HD player, DVD player and camera, etc.

2.3: Audio Input Interface

Audio input interface, input audio signals from DVD player, set top box, hardware player, etc.

4.5: Indicator

When input analog audio signal, LED indicator4, 5 light, when input digital AES/EBU signal, LED indicator4 lights.

2. Hardware Orientation

Interface Description

OUTPUT and Other Interface

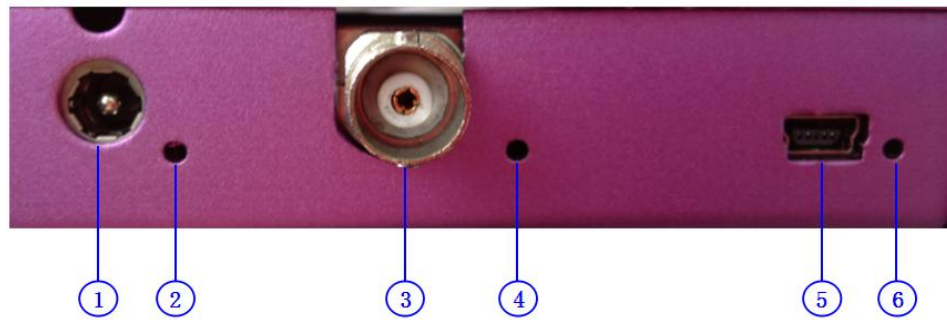

3: SDI Output Interface

SDI output interface, can connect the next level device with SDI interface.

5: USB Interface

USB interface, used to control the computer.

1: Power

This device uses the standard 12V/3A power supply.

2.4.6: Indicator

Power indicator 2 lights when device has power supply.

LED indicator 4 lights when output SDI signal.

LED indicator 6 lights when connect USB to computer.

2. Hardware Orientation

Dial Switch

Dial Switch

Dial switch shown as follows:

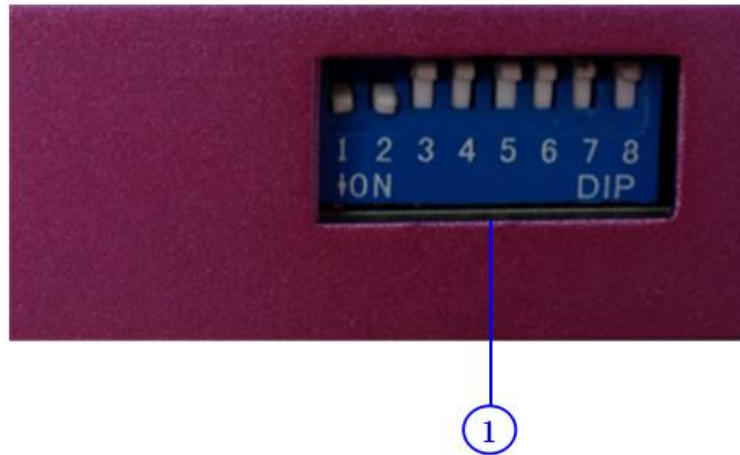

1. Dial Switch

The dial switch upwards is OFF, downwards is ON.

For specific operation and instructions, please refer to chapter 4:

[Dial Switch Function.](#)

3. Functional Description

Functional Description

1. CVBS input to SDI output.
2. Support input resolution of of SMPTE: 480i, 576i.
3. Support output resolution of SMPTE: 480i, 576i, 720p@50Hz, 720p@60Hz, 1080i@50Hz, 1080i@60Hz, 1080p@50Hz, 1080p@60Hz.
4. Support SCALE, left and right analog sound channel input, digital AES/EBU input, CVBS embedded audio input and mute function.
5. The LED indicator beside SDI interface lights when output SDI signal.

When input analog audio signal, the LED indicators beside L-ANALOG and R-ANALOG light.

When input digital AES/EBU signal, the LED indicator beside L-ANALOG or AES/EBU lights.

Functional Description Block Diagram

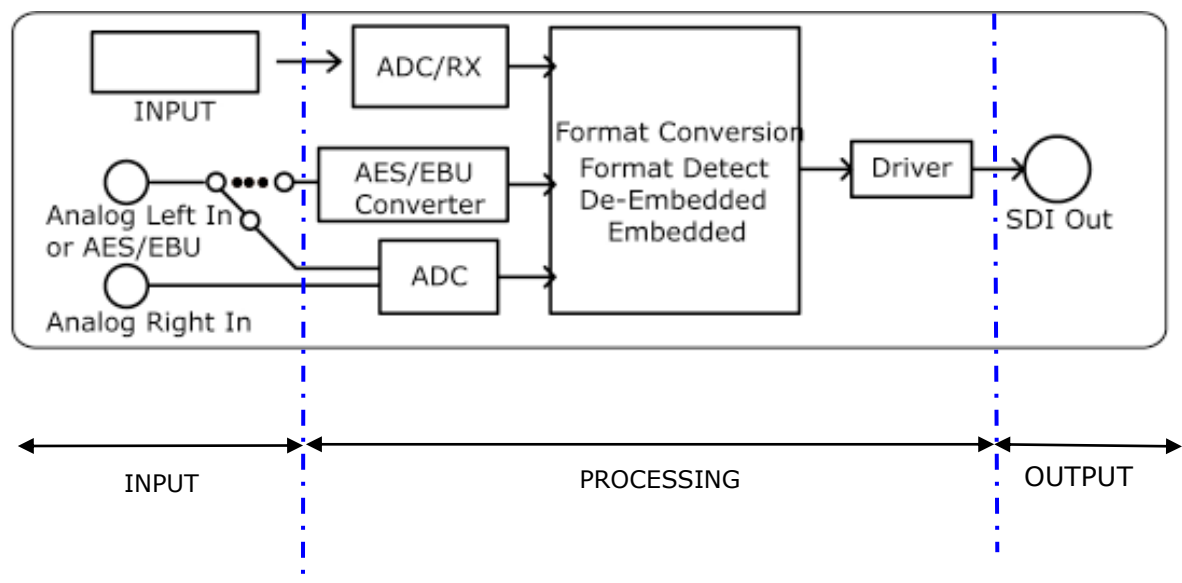

4. Dial Switch Function

Functional Description Block Diagram

In this chapter, we will introduce the operation and instructions of dial switch, following is the functional description block diagram:

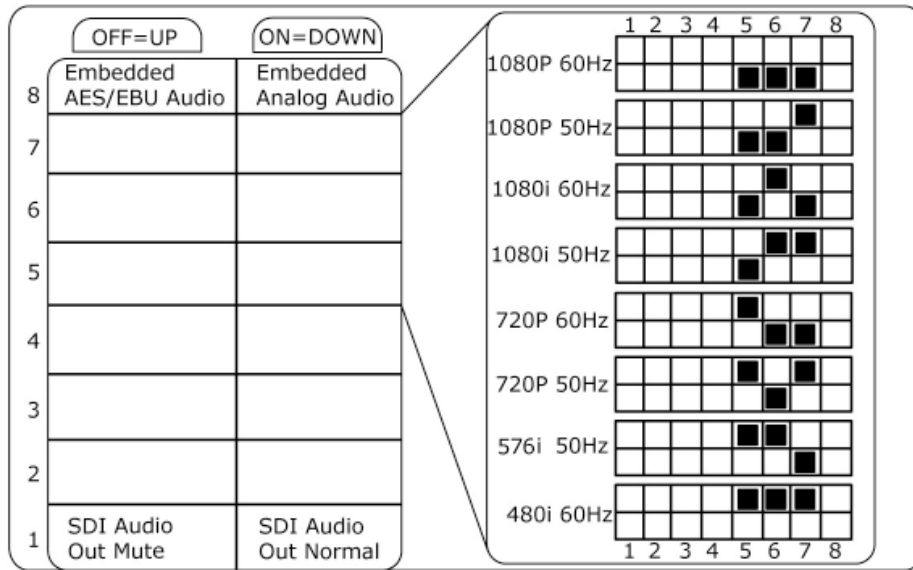

Instructions

The dial switch upwards is OFF, downwards is ON:

1. Dial switch1 OFF: mute.

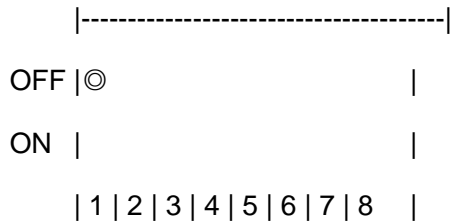

2. Dial switch 1 ON: cancel mute.

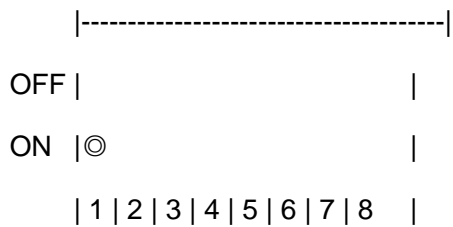

3. Dial switch 2 must be set to ON.

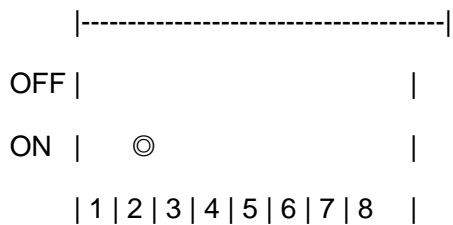

4. Dial switch 5, 6, 7 ON: SDI output resolution is 1080p 60Hz .

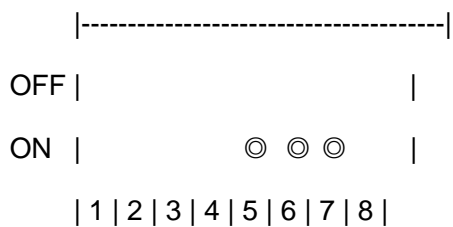

5. Dial switch 5, 6 ON, dial switch 7 OFF: SDI output resolution is 1080p 50Hz.

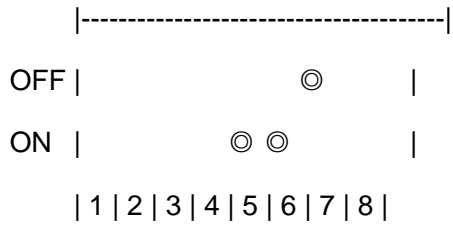

6. Dial switch 5, 7 ON, dial switch 6 OFF: SDI output resolution is 1080i 60Hz.

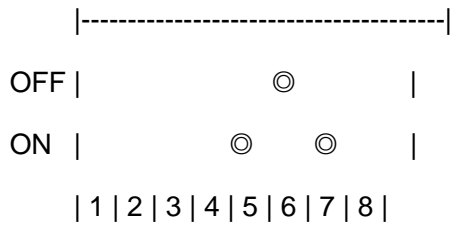

7. Dial switch 5 ON , dial switch 6, 7 OFF: SDI output resolution is 1080i 50Hz.

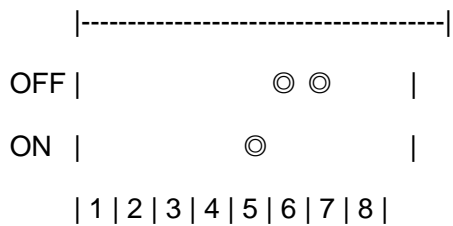

8. Dial switch 5 OFF, dial switch 6, 7 ON: SDI output resolution is 720p 60Hz.

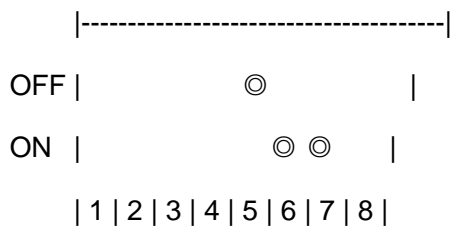

9. Dial switch 5, 7 OFF, dial switch 6 ON: SDI output resolution is 720p 50Hz.

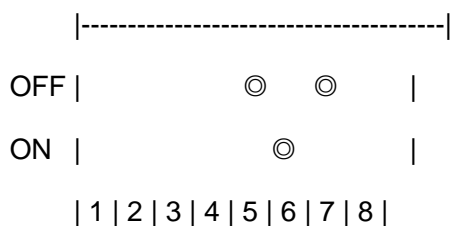

10. Dial switch 5, 6 OFF, dial switch 7 ON: SDI output resolution is 576i 50Hz.

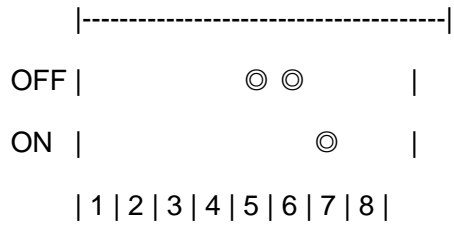

11. Dial switch 5, 6 7 OFF: SDI output resolution is 480i 60Hz.

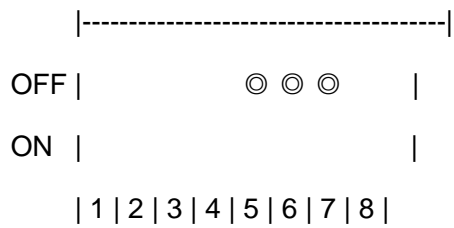

12. Dial switch 8 OFF: AES/EBU output, no analog audio output.

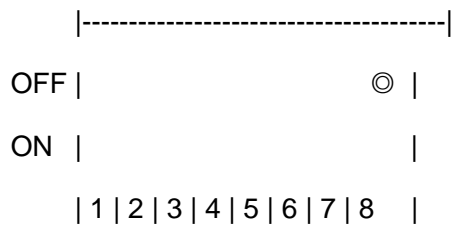

13. Dial switch 8 ON: L-analog and R-analog audio output, no AES/EBU output.

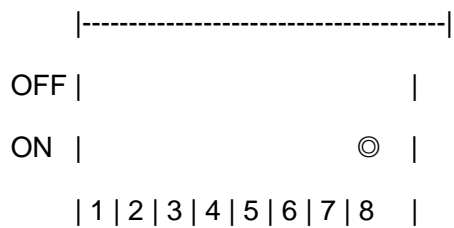

5. Communication Software Guideline

AVMSP series mini converter is equipped with user-friendly communication control software. User can set the audio display source and so on.

Running Software

Double-click AVMSP software  IfewMSP.exe, MSP 210C software interface is shown as follows:

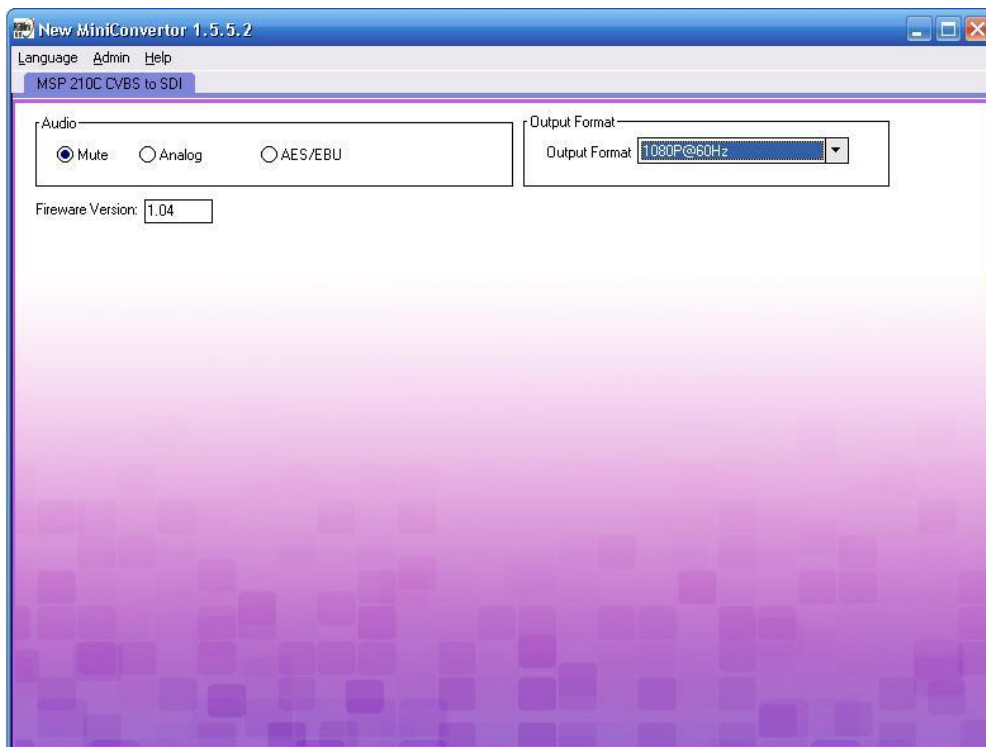

Use

Audio

Click the option box to select audio input source, including mute, CVBS, analog or AES/ EBU, for example, choose mute:



Version

Show the current device version information, the current version is 1.04 as shown below:

Fireware Version:

Output Format

User can choose the output format according to actual need.

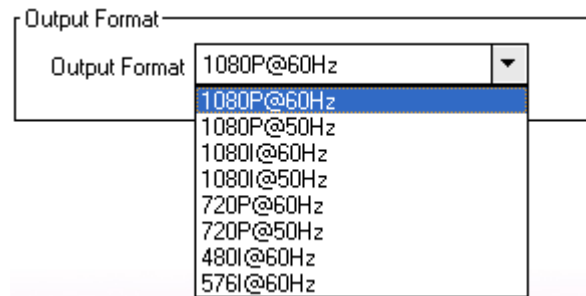

[Video Processor] Options

Language

This software supports both Chinese and English, User can switch the language by “Language” option.

Admin

Including “Advance Debug” and “Device Update”:

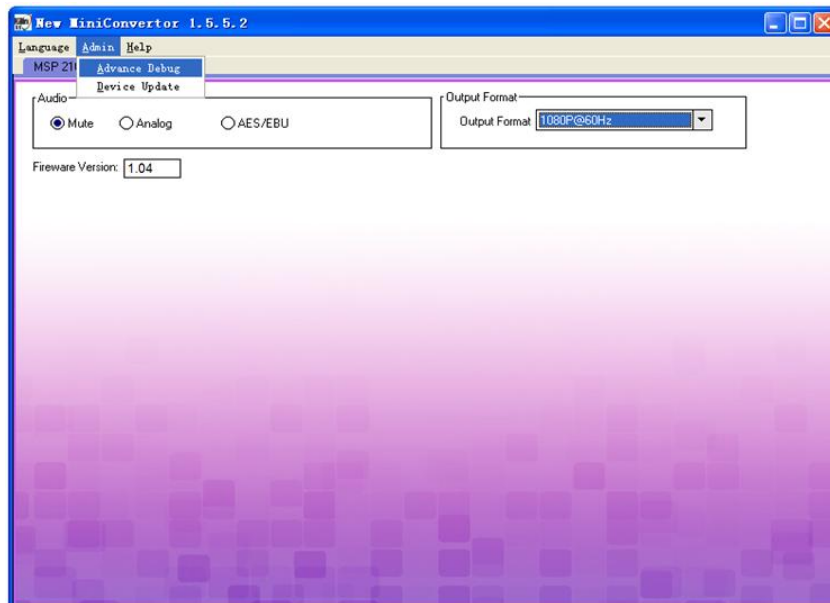

Advance Debug: User should input the password in the “Admin Password” dialog for advance debug.

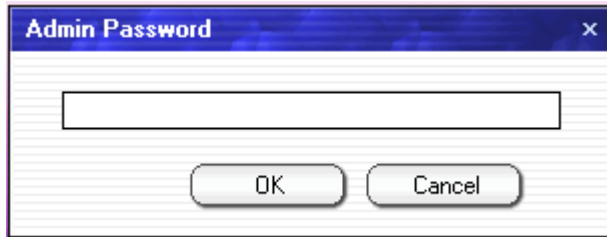

Note

Advance is only done by engineer. If need, please connect us for password.

Device Update:



Help

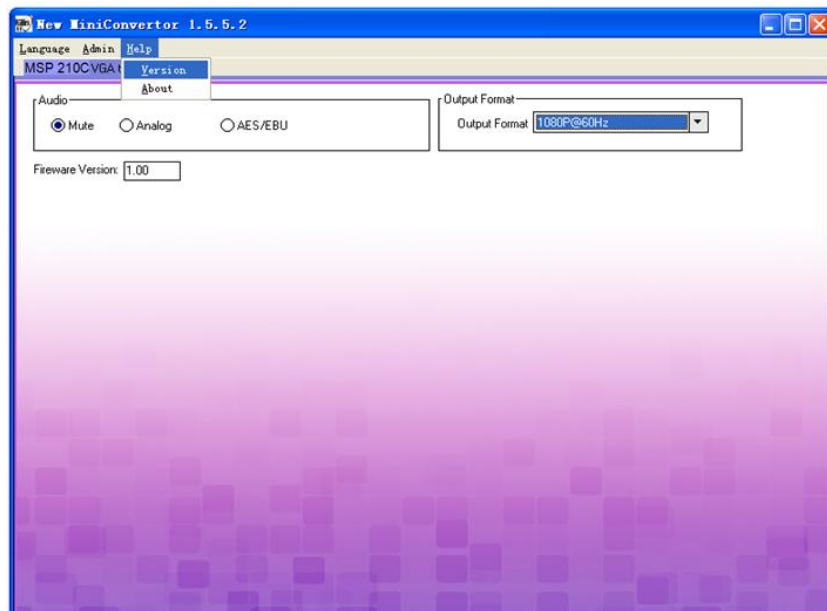

Version: Show the content of software update.

About: Show software version and company information.



A. Specification

CVBS input	
Number of inputs	1
Connector	BNC interface
Input resolution (Supported Standards)	SMPTE: 480i, 576i.
Embedded Audio Channels	Choose 1 in 2
Standard	PAL\NTST
Audio input	
Number of inputs	2
connector	Standard 1/4" socket
Audio standard	48Kbps 24bit balance analog audio, or 48KHz AES audio
SDI output	
Number of outputs	1
Connector	BNC interface
Output resolution (Supported Standards)	SMPTE 480i, 576i, 720p@50Hz, 720p@60Hz, 1080i@50Hz, 1080i@60Hz, 1080p@50Hz, 1080p@60Hz
Equalization	Belden 1694A 100m HD 1.485G, 300m SD 270Mbps
Function	
PPM	No support
TSL	No support
Format Conversion	No support
Frame Rate Conversion	No Support
Extras	
Assignment control	USB or dial switch
Power Supply	+12V standard 3.5" interface power module
Working Environment	0°C~45°C
Stored Environment	10% to 90%
Product Warranty	3 years parts and labor warranty

B. Contact Information

Warranty:

All video products are designed and tested to the highest quality standard and backed by full 3 years parts and labor warranty. Warranties are effective upon delivery date to customer and are non-transferable. RGBlink warranties are only valid to the original purchase/owner. Warranty related repairs include parts and labor, but do not include faults resulting from user negligence, special modification, lighting strikes, abuse(drop/crush), and/or other unusual damages.

The customer shall pay shipping charges when unit is returned for repair.

Headquarter: S603~604 Weiye Building Torch Hi-Tech Industrial Development Zone Xiamen, Fujian Province, P.R.C.

- **Tel:** +86-592-5771197
- **Fax:** +86-592-5771202
- **Customer Hotline:** 4008-592-315
- **Websites:**
 - ~ <http://www.rgblink.com>
 - ~ <http://www.rgblink.cn>
- **E-mail:** support@rgblink.com