

FLEX 16

Quick Start



- Fully Modular 16 ×16 signal architecture
- Mixed signal matrix switching
- Up to 33 mega pixels output splicing
- Load and save up to 256 presets
- Output resolution up to 2048x1152@60Hz / 2560x816@60Hz
- EDID management
- Remote control by XPOSE and RGBlink OpenAPI

CONTENTS

Product Introduction	3
Packing Configuration	4
Hardware Orientation	5
Front Panel	5
Rear Panel	7
Software Operation	8
Software Installation	8
Software Operation	11
Login to the Software	11
Connect Setting	13
Output Setting	15
Operation Mode	19
System Setting	31
Access control	34
Logout	35
Contact Information	37

Product Introduction

FLEX 16 is a matrix capable to distribute any input signal to any output signal through its consistent modular capability to control up to 16 different inputs and 16 different outputs independently. Different devices can be connected in each output and input. It supports HDMI, DVI, SDI, USB and HDBaseT input and output signals, as well as DP output. Flex 16 features in splitting mode for up to 2K1K, and simple managed by XPOSE software.

System Connection

RGBlink video processing solutions provide a range of flexible configuration options for professional applications.

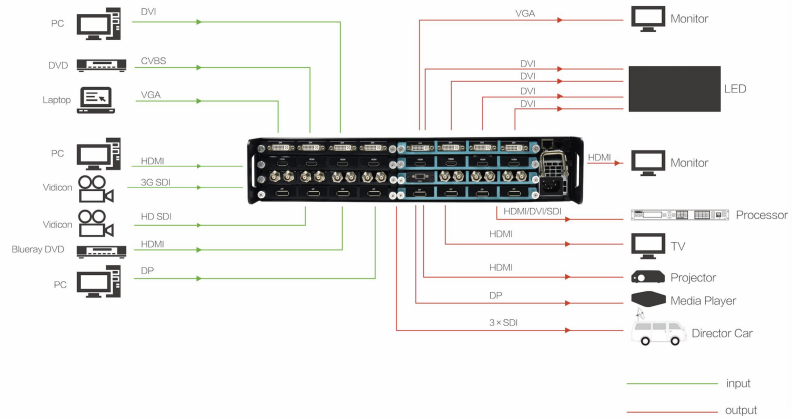

Flex 16 System Connection Diagram

Packing Configuration

AC Power Cable



Ethernet Cable



Converter DVI-VGA



Converter DVI-RCA



HDMI To DVI
Cable



Antistatic Bag



USB Disk



Note: AC Power Cable supplied as standard according to destination market





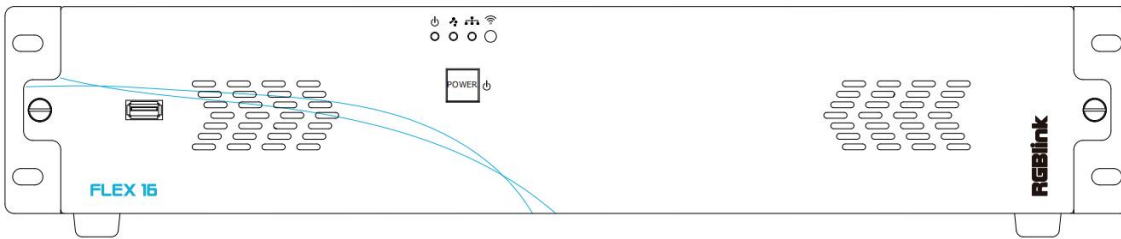

Upgrade tool package and user manual are stored in the USB disk, please keep it.

Hardware Orientation

Front Panel









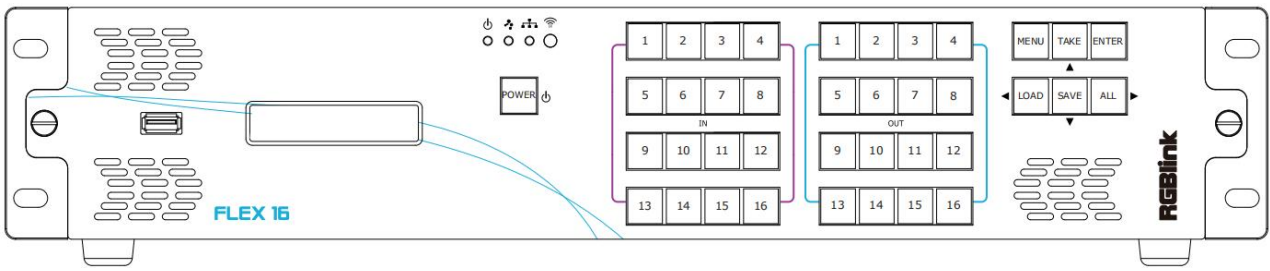





Standard Front Panel



Panel Instruction			
	USB interface for upgrading		LAN indicator indicating communication through LAN port , lights up when LAN port is connected, flashes when LAN communication happens
	Power indicator lights when device has power supply.		IR indicator Indicate IR communication flashes when there is communication IR e.g.remote control.
	Serial Port indicator lights up when serial port is connected, flashes when serial communication happens		Power-Standby button Keep pressing for 3S to switch

Matrix Panel for option



Panel Instruction			
	USB interface, for upgrading		IN 1~16, Input signal source selection button
	LCD Panel Show operation menu items		OUT 1~1, Output port selection button
	Power indicator lights when device has power supply.		Menu button to open up menu items and back
	Serial Port indicator lights up when serial port is connected, flashes when serial communication happens		Switch input source for matrix output
	LAN indicator indicating communication through LAN port , lights up when LAN port is connected, flashes when LAN communication happens		Enter subsidiary menu or confirm operation
	IR indicator Indicate IR communication flashes when there is communication IR e.g.remote control.		Load setting from SAVE
	Power-Standby button Keep pressing for 3S to switch		Save setting to device
			Choose all outputs in Matrix operation mode.

Rear Panel

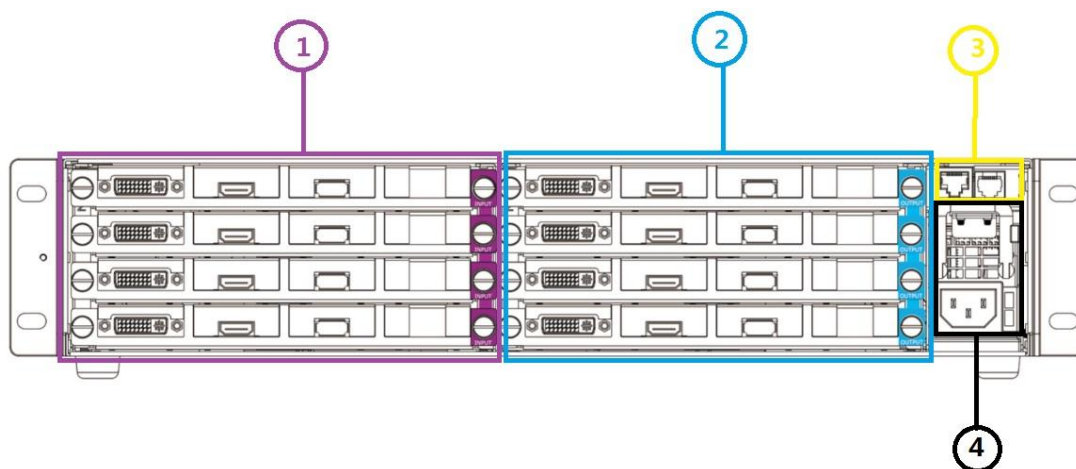

Input Interface

1	<p>Input Module Slots</p> <p>Supports input signals including HDMI, DVI, SDI, USB and HDBaseT.</p>
---	---

Output Interface

2	<p>Output Module Slots</p> <p>Supports input signals including HDMI, DVI, SDI, USB, HDBaseT and DP.</p>
---	--

Control Interface

3	LAN Port and Serial Port
---	--------------------------

Power Connection

4	Power Supply Module, IEC-3
---	----------------------------

Software Operation

Software Installation

Minimum Requirements

Windows

Operation System	Windows 7/8/10
Processor	1GHz/32 bit or 64 bit processor
Memory	2Gb
Hard Disk	16Gb
Graphics	128Mb/DirectX9
Display	1280X720

Mac

Operation System	Mac OS
Processor	1.0GHz+
Memory	512M+
Hard Disk	512M+
Graphics	512M+
Display	1366x768



1. Double click icon  , it will pop-up the Installer Language box, select the language, for example, select “English”, and click “OK” to confirm.



It will pop-up the installer box, and click “Next” to install, as follows:



2. Select “Browse...” to select the XPOSE software install location and click install:

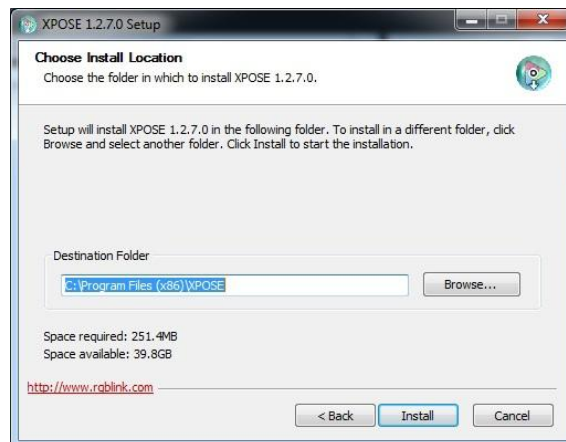

User should get the rights in “Roles Management” when install the software to disk C if the system is Windows 7 or above.

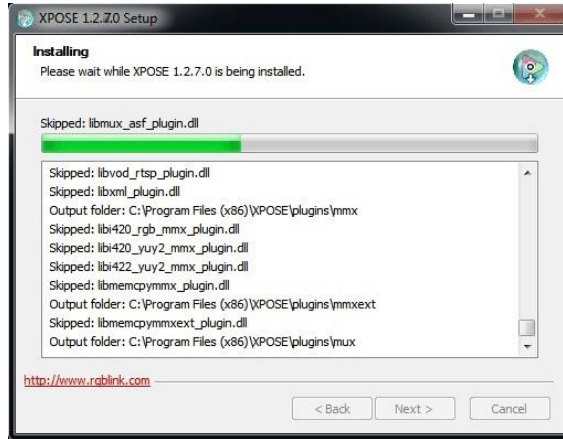

3. Click “Finish” and is ready to run the XPOSE management software:



Software Operation

Login to the Software



1. Double click the icon XPOSE on the desktop, then login into the interface. The user name is Admin, and default there is no password. Select “FLEX 16”, select language “English” and enter the software by clicking “Login”.



2. If user wants to change the language to Chinese, click the drop down arrow after “Language” and select “Chinese”, then click “Login” to enter the software.



After entering the software, the main interface shows as follows:

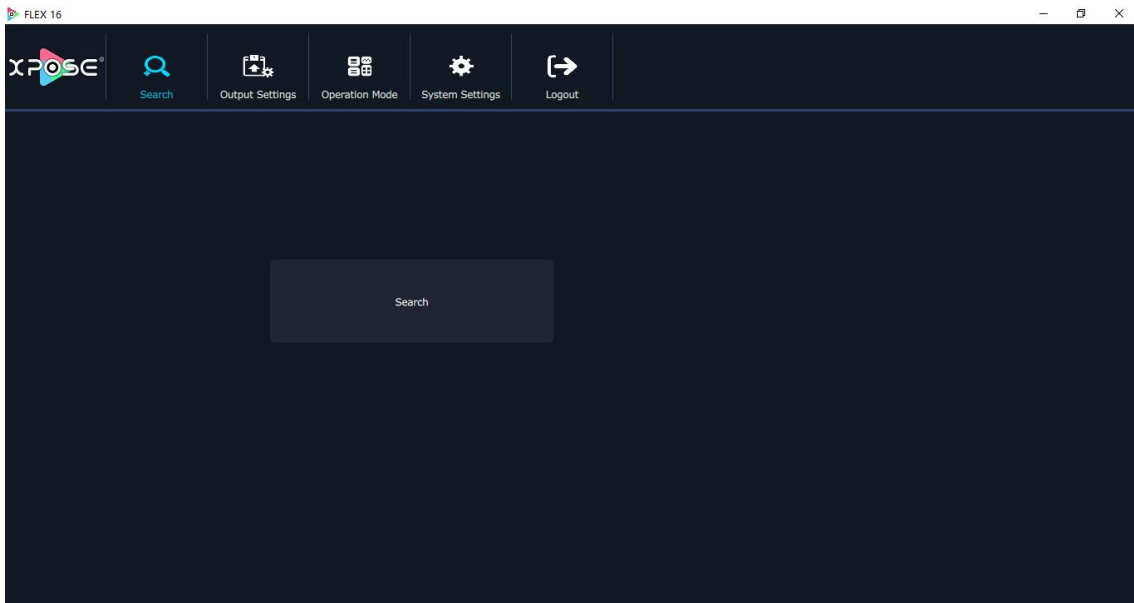

XPOSE management software consists of Output Setting, Operation Mode, System Settings, Access Control and Log out. In the following parts come with the details.

Connect Setting

The remote controller PC which runs XPOSE connects with Flex 16 by the network cable or USB-RJ11 serial cable (with the standard accessories).

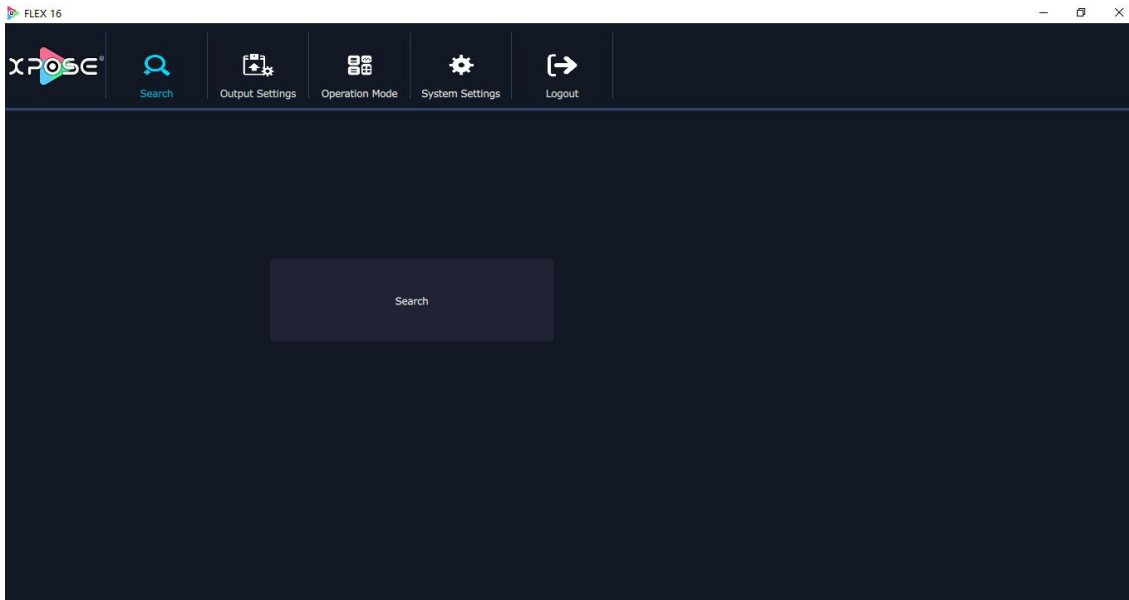

After login on XPOSE, Search device and find FLEX 16

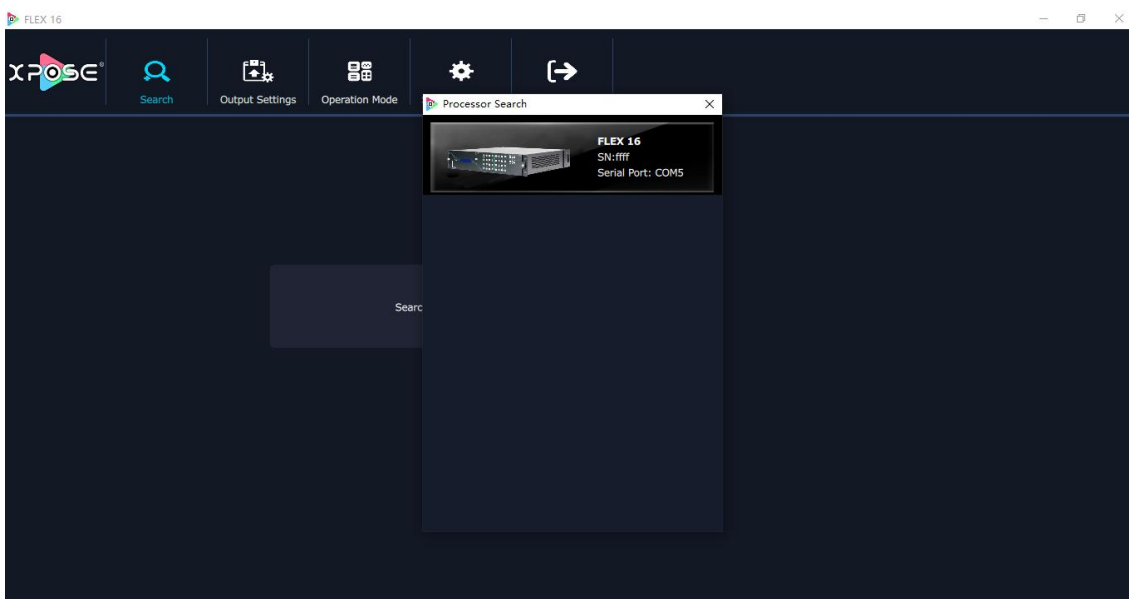

Click the FLEX 16 icon and sync

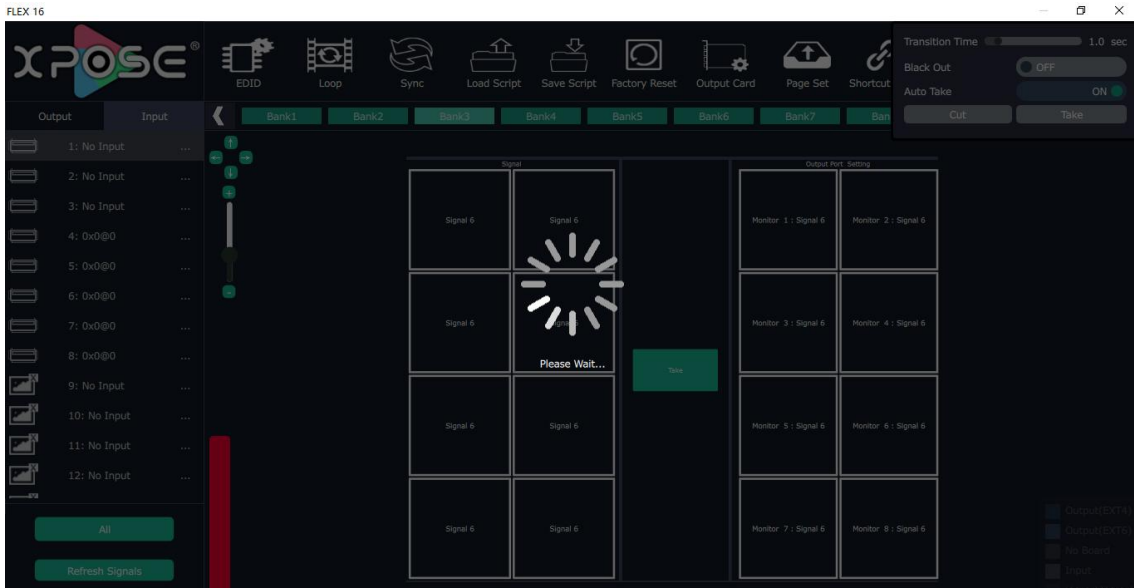

And sync done.

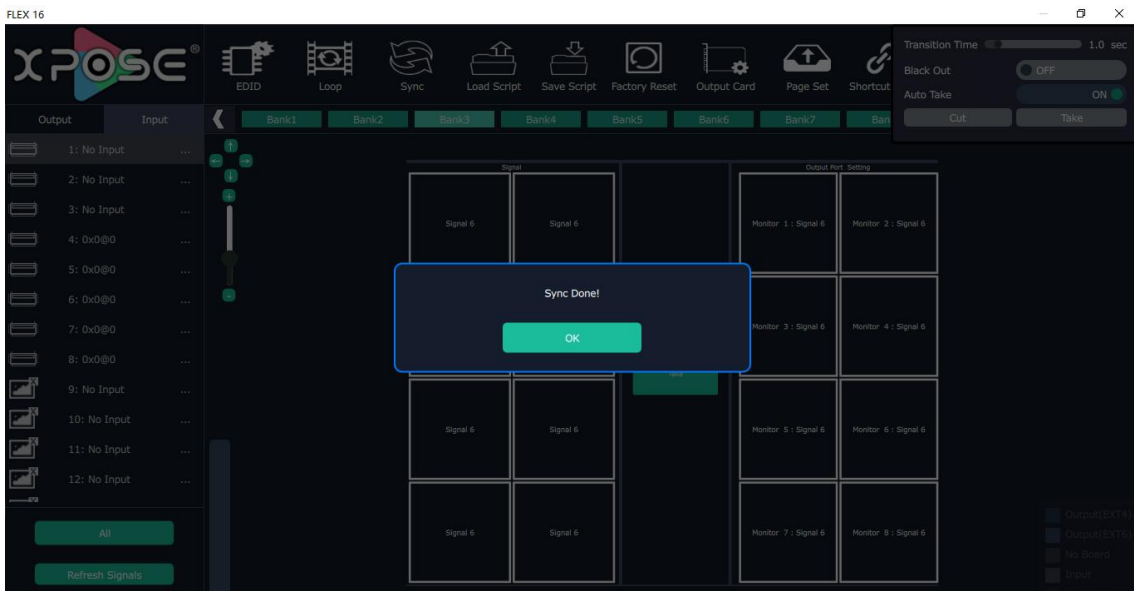

Output Setting

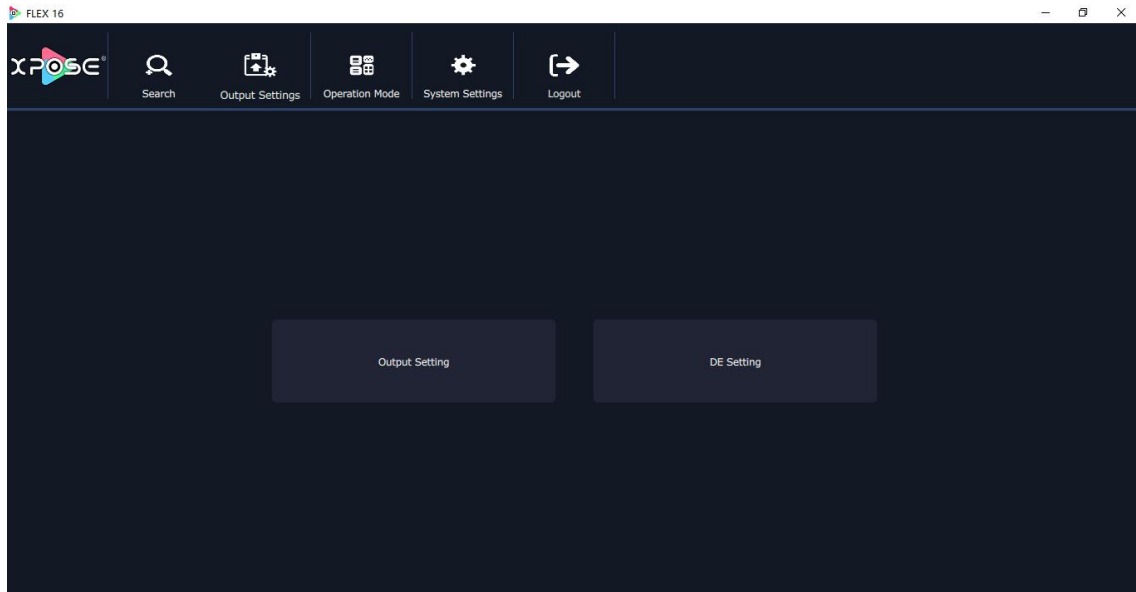

Output setting

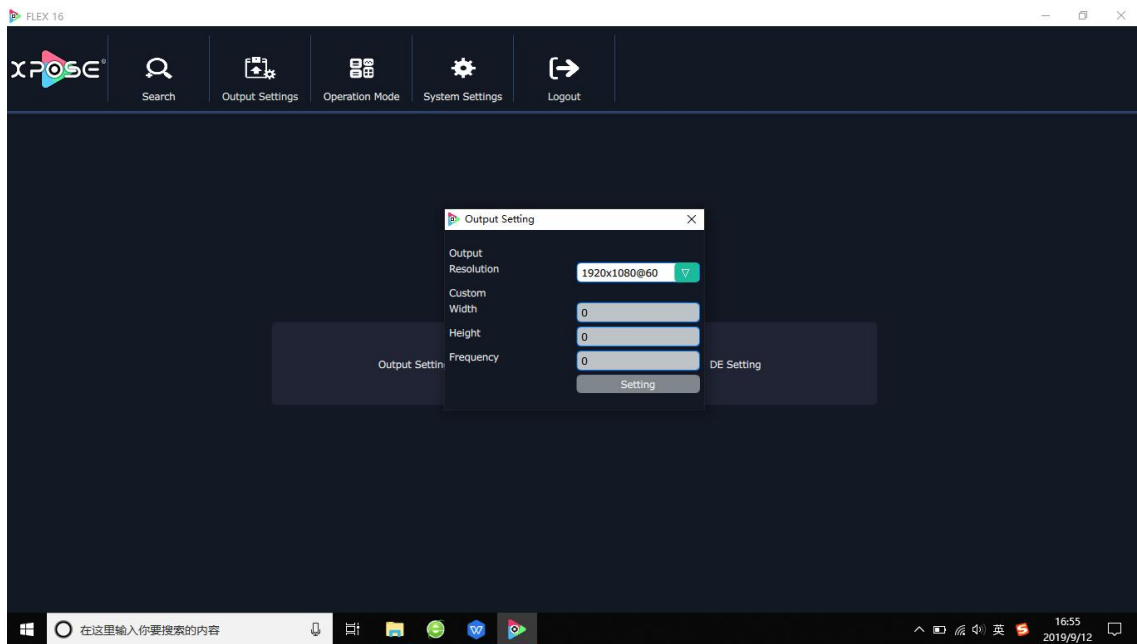

28 types of standard resolution available to choose.

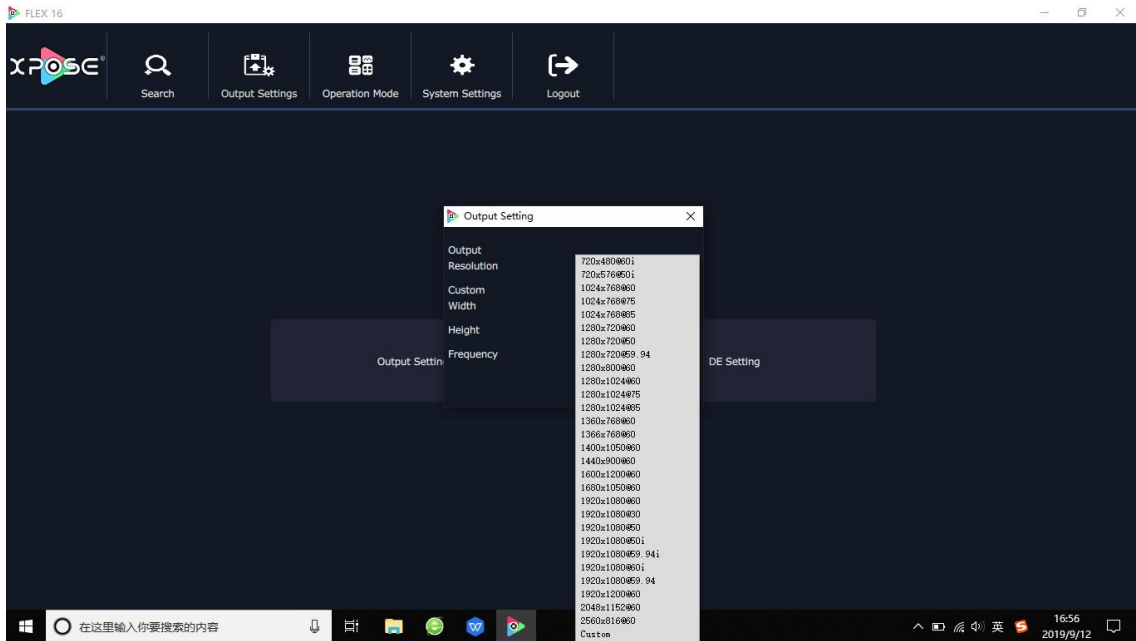

User can custom the resolution if no proper resolution in the list,

Note:avoid using following resolution

720x480i@60Hz and 720x576i@50Hz (not supported on all output modules),

2560*816@60and 2048*1152@60 (not supported on DVI and HDMI output) .

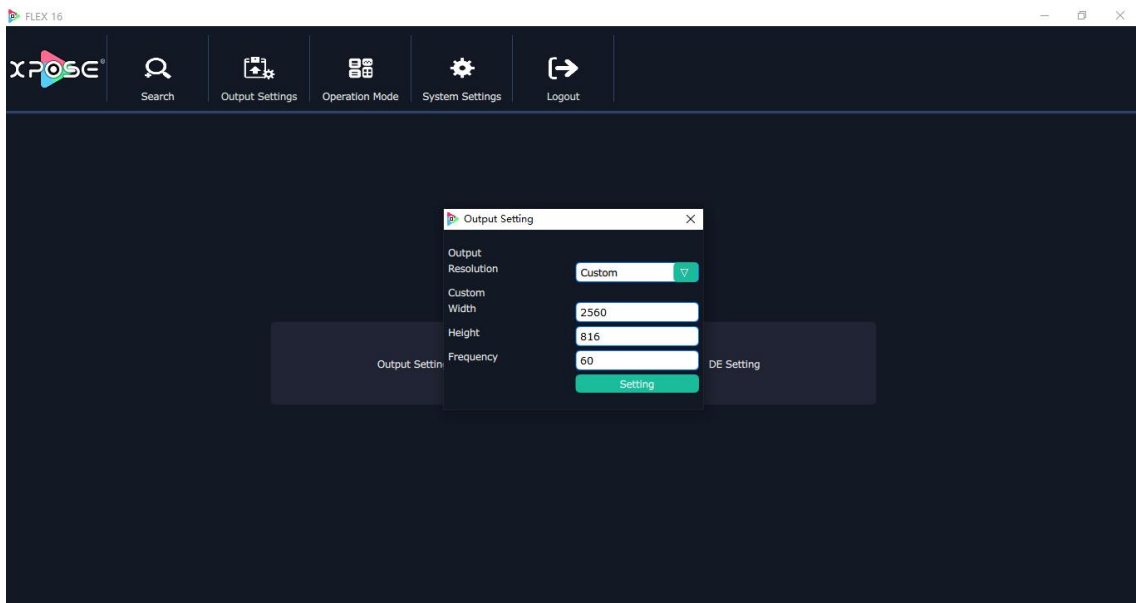

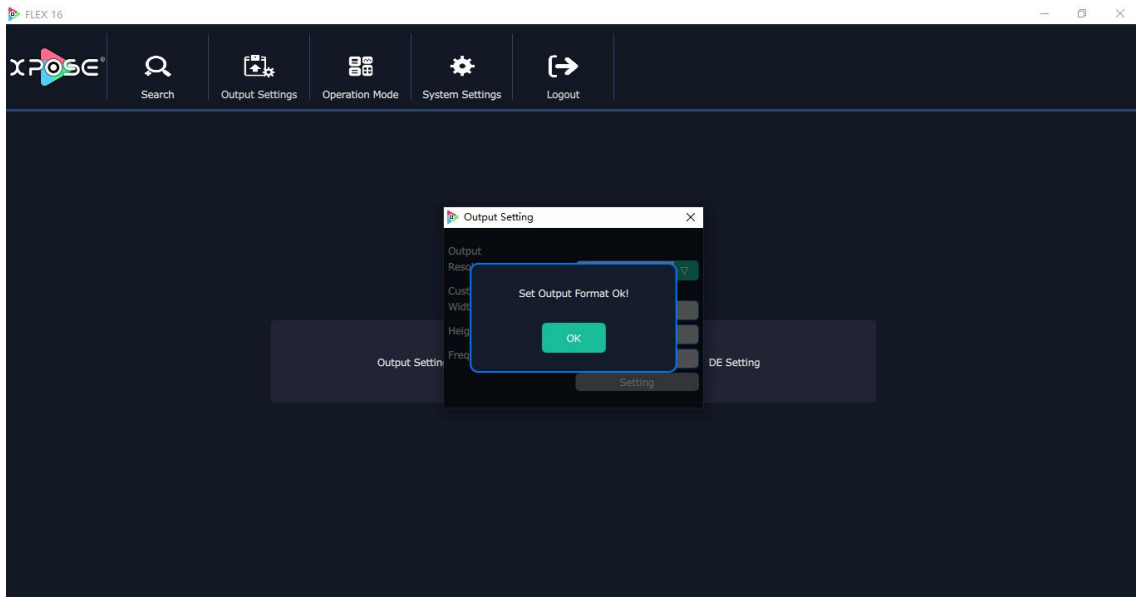

Output setting is for all output ports from one output EXT (EXT-4 or EXT-6)

DE setting

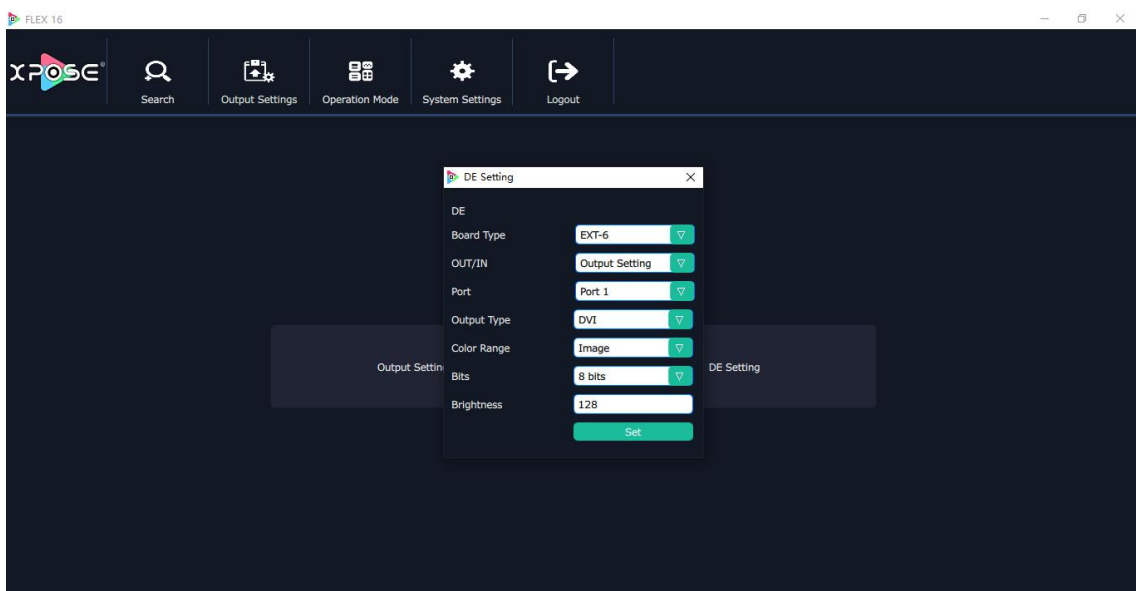

Board type:EXT-6 (EXT 4F-OS Splicing EXT interface) EXT 4 (EXT 4F OM Matrix EXT interface, EXT 4F IM matrix input ext interface)

Port :1-16

Output Type:DVI or HDMI

Color Range:Image or Video

Bits:DVI 8bits, HDMI 8bits|10bit| 12bit

Brightness:0-128

Out/In: Output Setting or Input Setting, when choose EXT 4, users need to choose output setting or input setting.

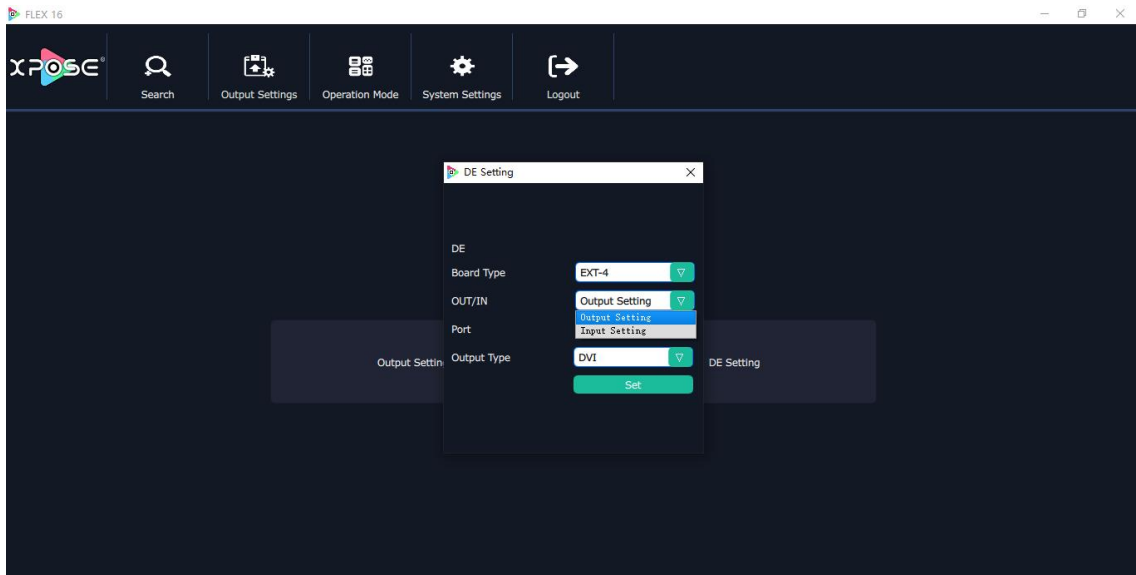

DE setting done

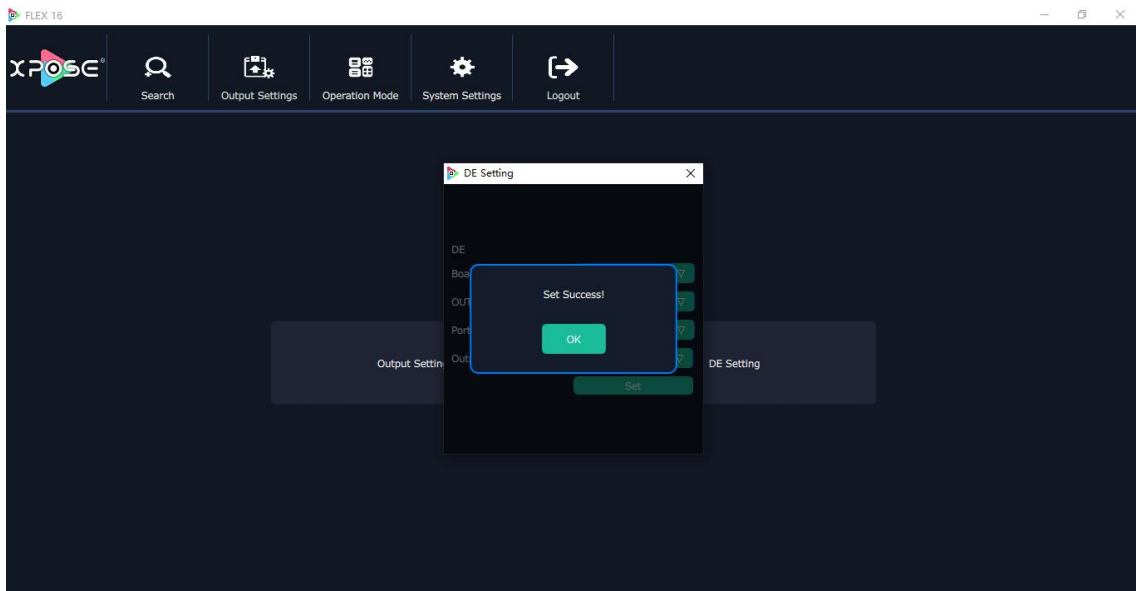

Operation Mode

There are 2 working modes, including the Matrix mode and Splitting Mode. Click the “Operation Mode”, and enter the interface as follows:

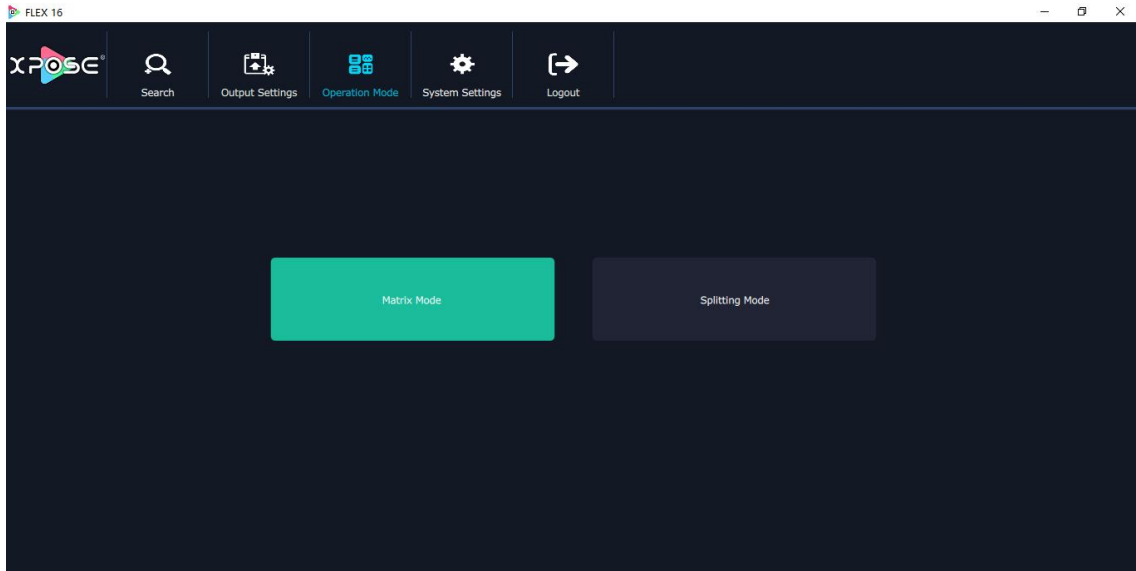

Matrix Mode and Splitting Mode are included in operation mode, specific as follows:

1. Matrix Mode

Click the “Matrix Mode”, and enter to the interface as follows:

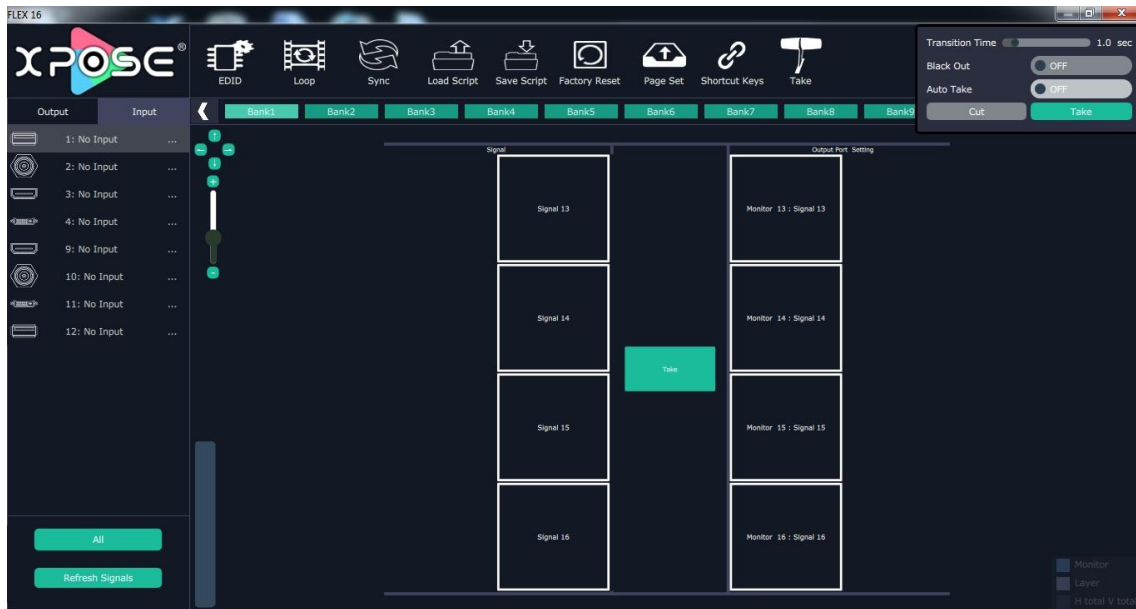

In matrix mode, is available signal selection, bank selection, transition time and black out setting.

Default source 1 to monitor 1, source 2 to monitor 2, and so on. Select the signal, and drag it to the source that will set. For example, set signal 3 for source 13, as shown in the figure below:

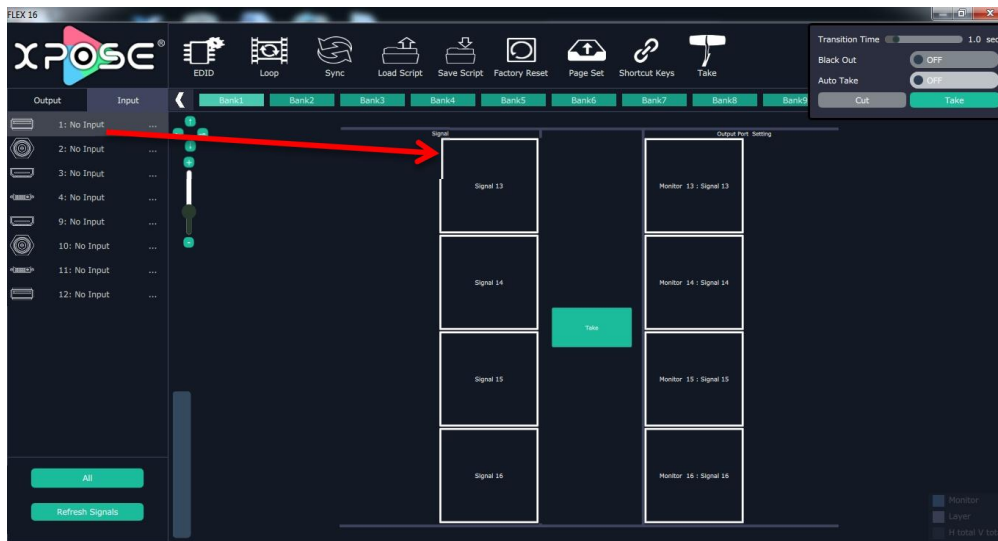

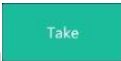
Source 13 will be switched to signal 3, click source 1, then click “TAKE” icon , the signal will be switched to the corresponding monitor. Connect the signal to the corresponding output after setting.

Two ways can configure the matrix mode in Flex 16m (with Matrix Front Panel), using the XPOSE software or using the buttons on the front panel to select the output through which the input signal will be delivered. If the user selects Flex 16s, the matrix mode can only be configured from the XPOSE software.

2. Splitting Mode

Click the “Splitting Mode”, and pop-up window as follow:

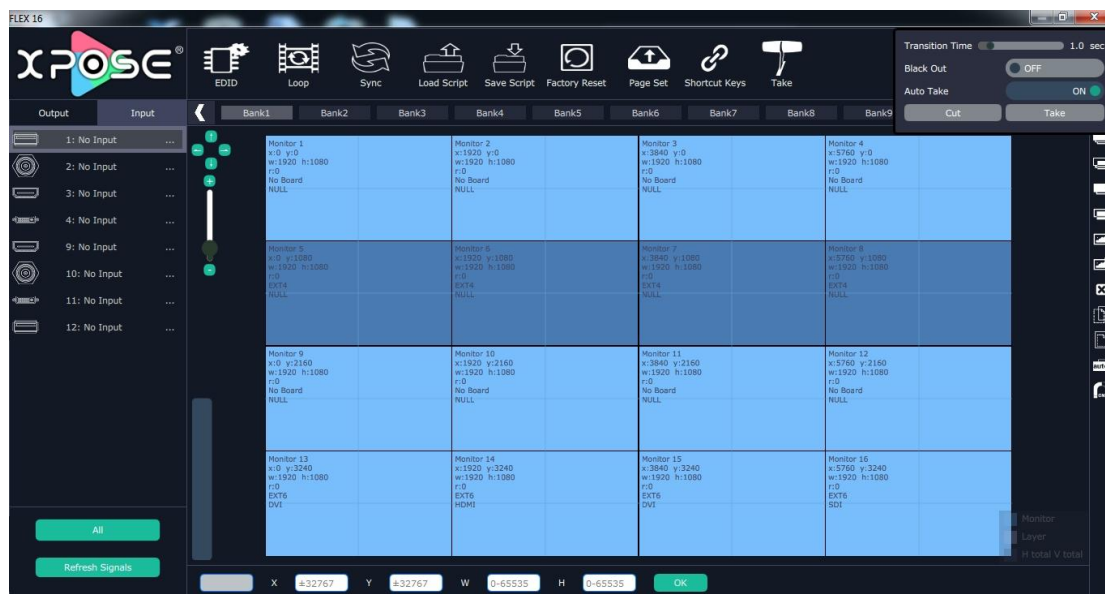

Signal List

The signal list is shown as follows:

Output	Input
 1: 64x64@0	...
 2: No Input	...
 3: No Input	...
 4: No Input	...
 9: No Input	...
 10: No Input	...
 11: No Input	...
 12: No Input	...

It displays the input module type, the quantity of inputs and input format. Right click the input for the following settings:

Change Name: Select “New Name”, and input the new name, click “OK” after setting.

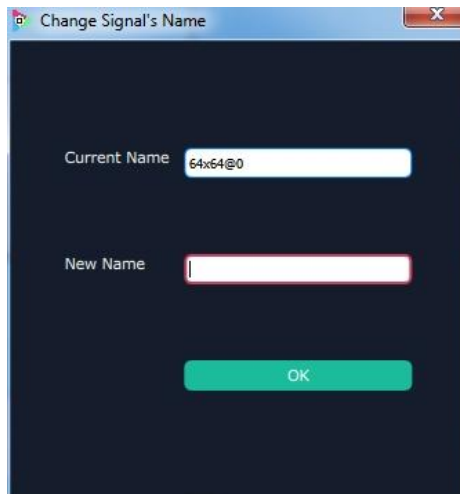

Refresh Signals: Right click the input and select “Refresh Signals”. If there is signal, it will show the input format, or it will show “No Input”.

USB Player: Right click the USB input, and select “USB Player”, it will enter to the USB Player interface, including movie and picture, default play the USB picture.

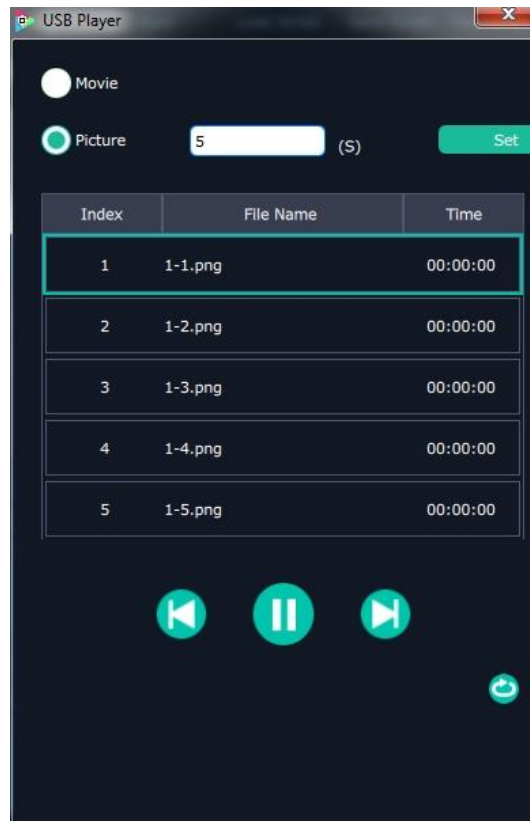

USB movie player setting: Can select play in order, random, single cycle and all cycle, switch to pre or next, pause or play, and read the movie name, progress bar and time.

USB picture play time: Click the picture, it will display the setting interface, default the time is 0s. Set the switch time, and click "Set".

USB picture player setting: Can select play in order, random, single cycle and all cycle, and switch to pre or next, pause or play.

USB Upgrade: Put the file in the form of MERGE.bin to the USB disk root directory, and connect to the USB input. Right click the USB input, and select "USB Upgrade" to begin to upgrade USB. (Note: upgrade is only for the USB port that connected, user need to upgrade the four USB ports respectively.

Set Input Property: Right click the input and select "Input Property", it will enter to the interface as follows:



Scale: Set the X, Y, width and height.

Crop: Crop the left, top, width and height.

Display Mode: Select "Live" or "Freeze".

Mirror: Enable or disable the mirror function, default "OFF".

Bypass Mode: Enable or disable the bypass mode. When select "ON", the output format will be the same with the input format.

Alpha: Set the alpha, the adjustment range is 0~128.

Sharpness: Set the sharpness, the adjustment range is 0~100.

Brightness: Set the brightness, the adjustment range is 0~100.

Contrast: Set the contrast, the adjustment range is 0~100.

Saturation: Set the saturation, the adjustment range is 0~100.

Color Term: Set the color temp (red, green and blue), the adjustment range is 0~100.

Reset: Select "Reset", the input property will be recover to factory setting.

Test Pattern: Slide the Test Pattern switch to enable or disable the function.

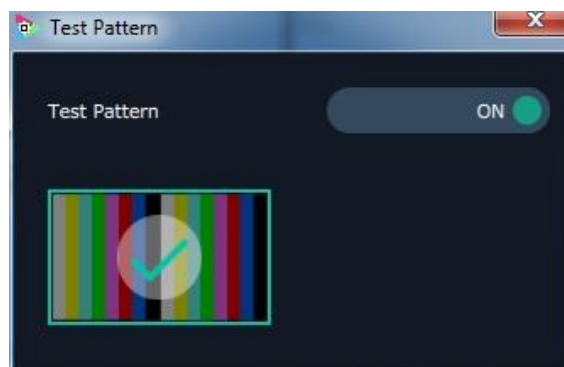

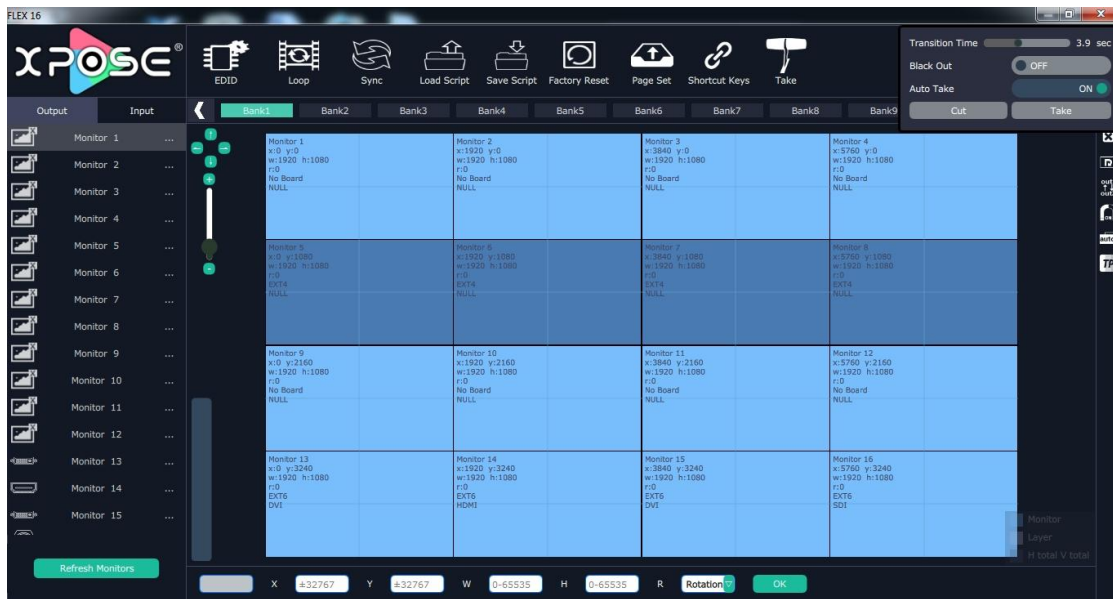

Output Setting

Click on shortcut , it will enter the interface as follows:



Close monitor: Click the icon  on the top right corner of the monitor to close one monitor, or click the shortcut

 on the right side of the interface to close all monitors.

Reset outputs: User can reset outputs by clicking the shortcut  on the right side of the interface.

Swap outputs: User can swap outputs by clicking the shortcut  on the right side of the interface, as shown in the figure below.

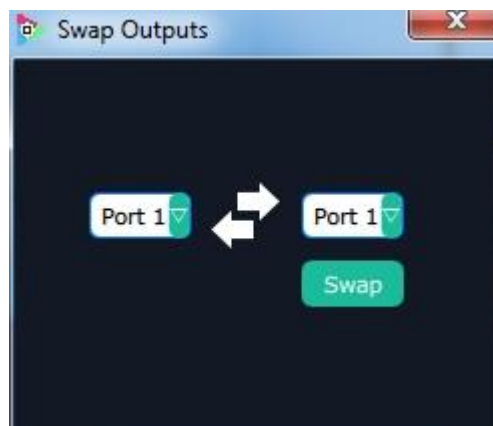



Auto tile: User can enable or disable the auto tile function by clicking the auto tile shortcut on the right side of the interface. If select auto tile “ON”, the layer will automatically snap to the output grid when move the layer to the position within the threshold value.

Monitor Size and Position Setting: Move the mouse to the lower right brink of the monitor, and press the left key of the mouse. Move the mouse to the suitable position and release the mouse. But this method can only adjust the size and location roughly, if an accurate adjustment is needed, select the monitor, and set the X, Y, width and height in the bottom of the interface.



Monitor Size changed equivalently: Select any monitor, for example, select monitor 1, and adjust the size. Click this monitor, then press button C and don't let go, select the monitor that will set, the size of the selected monitor will be changed to the same size of monitor 1, as shown in the figure below:

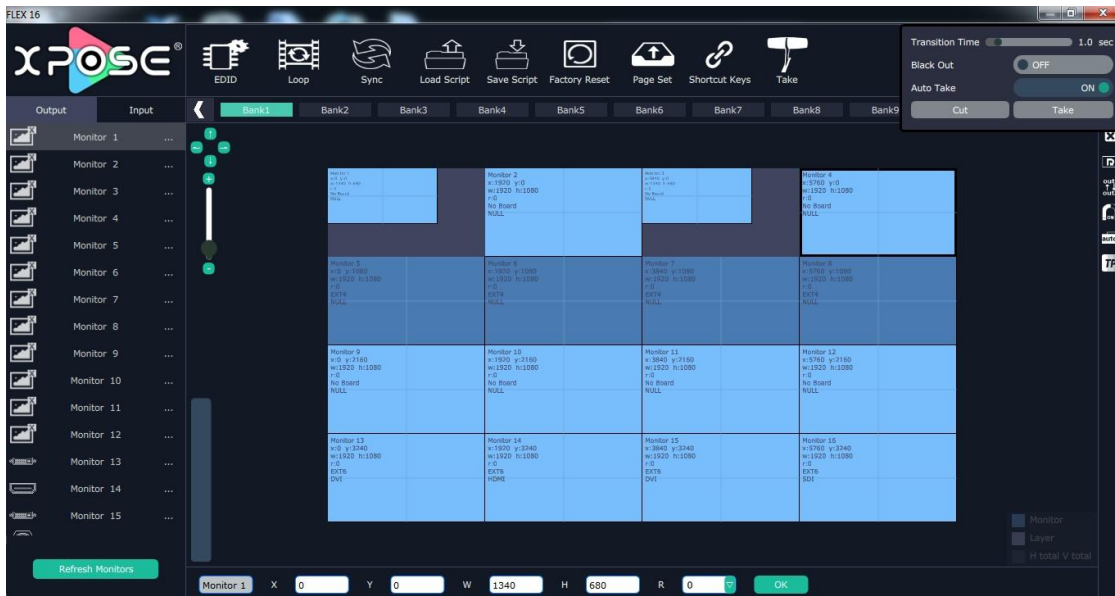

Rotation: Select the monitor, and set the rotation as 0°, 90°, 180° and 270° in the bottom of the interface. Click “OK” to confirm. As shown in the figure below:



Right click the monitor can also rotate the monitor.

Output Area Size Setting: Move the mouse to the output area and slide the mouse wheel, the output area size can be zoom in and out.

Layer Setting

New Layer: In input screen zone of controlling software, press the left mouse key and drag on the intended output screen to cover the whole current screen. And the below interface will be displayed. A layer can also be opened by double right clicking the left signal source to be shown on the window.

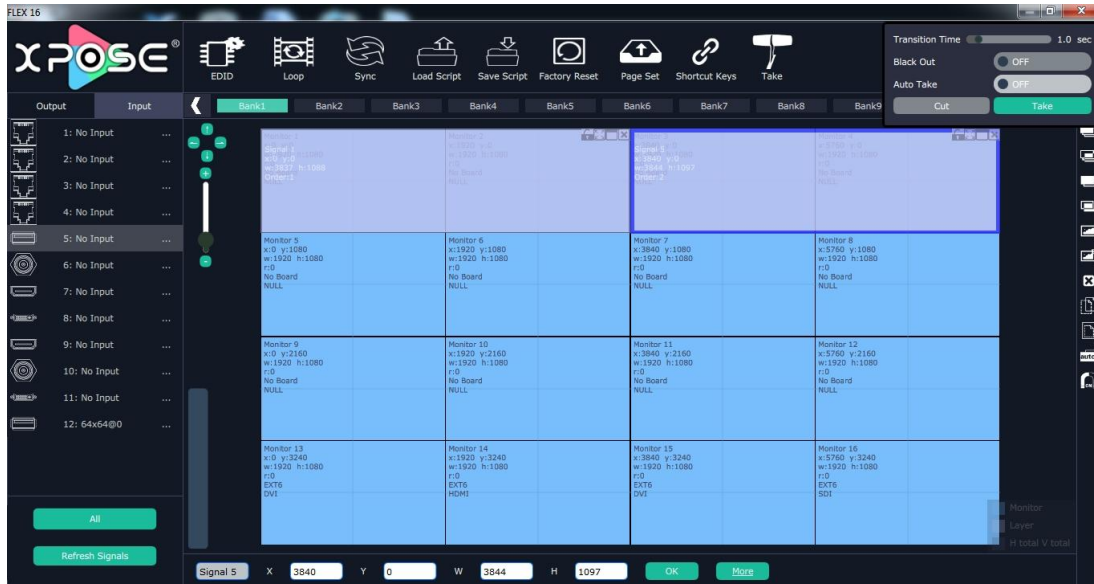



Each slot supports up to 4 layers that can be set up through each output as required without exceeding the limit. Flex 16 supports up to 16 layers, if an image crosses over two outputs then it is considered as 2 layers, or if an image crosses over the four outputs, then it is considered as 4 layers and no more layers can be used in that slot. The more signals cross over an output, the fewer images are available. If one image crosses over the 16 outputs, then no more layers can be set.



Adjust Layer: Two ways can change the size and location of the opened layer:



a. Drag the opened layer by mouse. The details are: move the mouse to the brink of the opened layer, when the mouse shows “<—>”, press the left key of the mouse and drag the window to a suitable size and then release the mouse. Or move the mouse to the lower right of the opened layer, press the left key of the mouse and drag the window to a suitable size and then release the mouse. Move the mouse to the opened layer and press the left key of the mouse and move the mouse, then the layer will be moved, release the mouse when moved to the suitable location. But this method can only adjust the size and location roughly, if an accurate adjustment is needed, the second method can be used.

b. Select the layer to be adjusted, and set the X, Y, width and height in the bottom of the interface.







Hierarchical relations between layers: After creating the layers, the hierarchical relations can be changed by the following: click the shortcut key bring layer to front “”, send layer to bottom “”, layer forward “”

or layer backward “”. The layer can be set as background by click “” and click “” to close layer background.

Close one layer or all layers: Click the icon  on the top right corner of the layer to close one layer, or click the shortcut key “” to close all layers.

Lock the layer: Click the icon  on the top right corner of the layer to lock the layer, the layer can't be moved or adjusted if be locked.

Full the layer: Click the icon  on the top right corner of the layer to full cell, and click the icon  to full screen.

Copy and paste bank: Select the bank that to copy, and click the copy bank shortcut “” on the right side of the interface, then select the bank that to paste, and click the paste bank shortcut “”. The selected layer will pasted to the bank.

Adaptive: If scale the output area to a large area, click the adaptive shortcut “” on the right side of the interface, the output area will be return to the best position.

Layer Property Setting: Select the layer to be adjusted, click the More shortcut “” in the bottom of the interface, and enter the interface as follows:



Scale: Set the X, Y, width and height.

Crop: Crop the left, top, width and height.

Display Mode: Select “Live” or “Freeze”.

Mirror: Enable or disable the mirror function, default “OFF”.

Bypass Mode: Enable or disable the bypass mode. When select “ON”, the output format will be the same with the input format.

Alpha: Set the alpha, the adjustment range is 0~128.

Sharpness: Set the sharpness, the adjustment range is 0~100.

Brightness: Set the brightness, the adjustment range is 0~100.

Contrast: Set the contrast, the adjustment range is 0~100.

Saturation: Set the saturation, the adjustment range is 0~100.

Color Term: Set the color temp (red, green and blue), the adjustment range is 0~100.

Reset: Select "Reset", the input property will be recover to factory setting.

Take

The take interface is shown as the figure below:



Set the transition time, and the adjustment range is 0~10S.

Slide the black out switch to enable or disable the black function. Auto take on is the default state. If select black out and auto take on, the preview image will black or seamless switch to LED display instantaneously.

Click "Cut" or "Take", the preview will be cut or seamless switch to LED display.

EDID



Click the EDID shortcut "EDID", and pop-up window as follows:

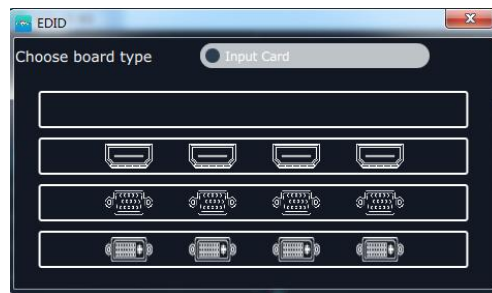

The special display project or LED display application would like to require special resolution settings to meet the requirement. Select the input or output board to read and write the EDID. As shown in the figure below:

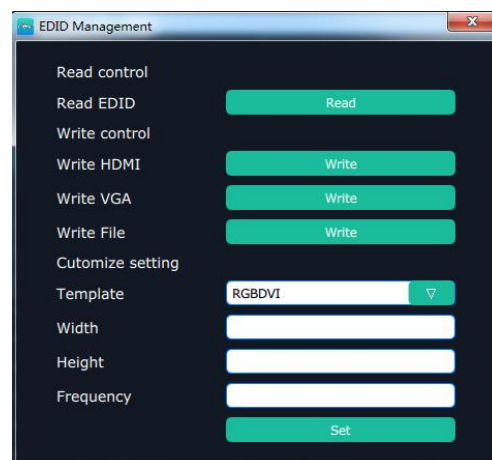

Loop



Click the loop shortcut “**Loop**”, and pop-up window as follows:

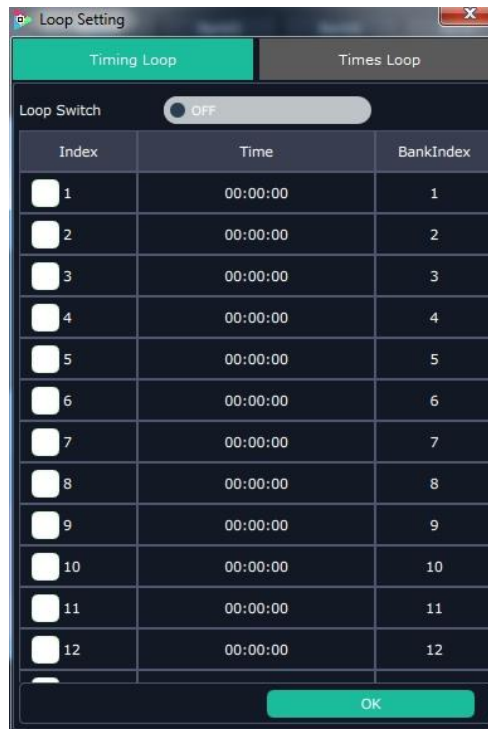

Slide the loop switch to enable or disable the loop function for the bank. If select “ON”, the bank play time can be set.

Sync



Click the sync shortcut “**Sync**” to synchronize the current data.

Load Script



Click the load script shortcut “**Load Script**”, user can load the data from the computer.

Save Script



Click the save script shortcut “**Save Script**”, user can save the data to the computer.

Factory Reset



Click the factory reset shortcut “Factory Reset” to reset to factory settings.

Page Set



Click the page set shortcut “Page Set” to load and save pages.

Shortcut Keys



Click the shortcut “Shortcut Keys”, and pop-up window as follows:

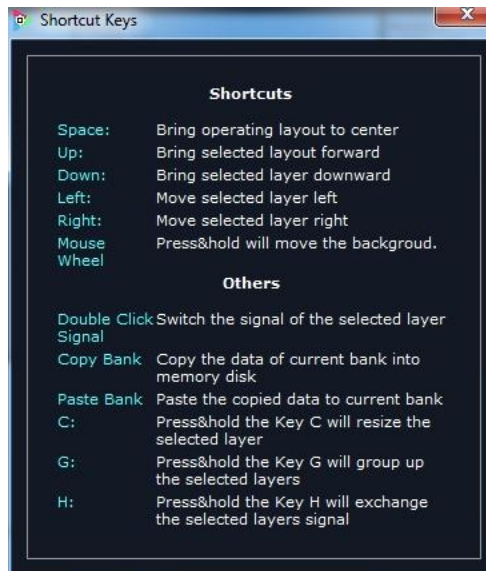

Use shortcut key to operate fast and easily.

System Setting

Click "System Settings" in the main interface:

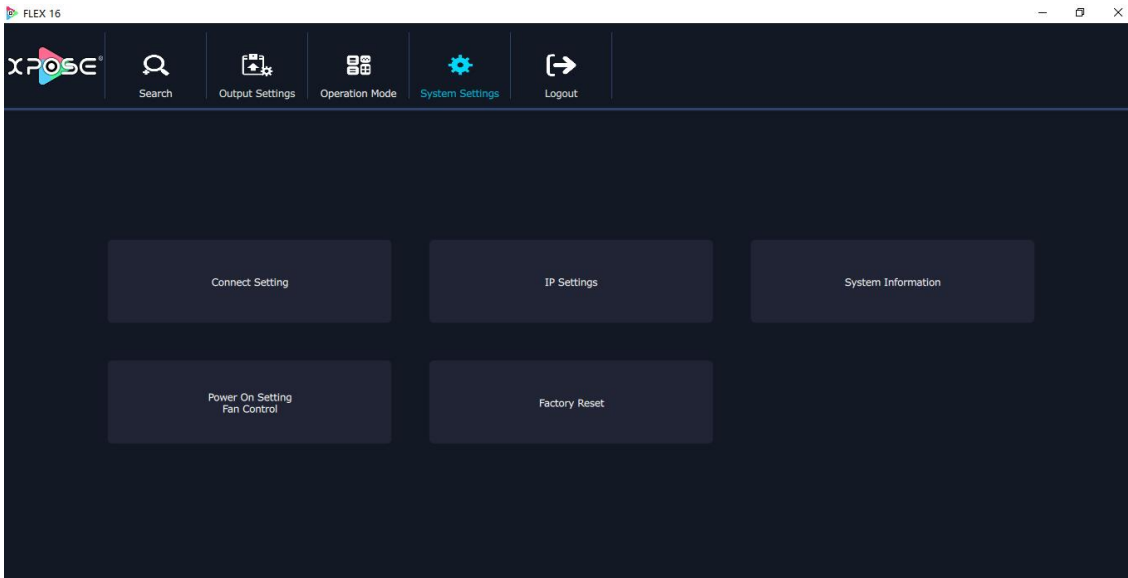

1. Connect Setting

Click "Connect Setting": Select "COM Port" and "Baud Rate", click the drop down arrow after them, and click "OK".

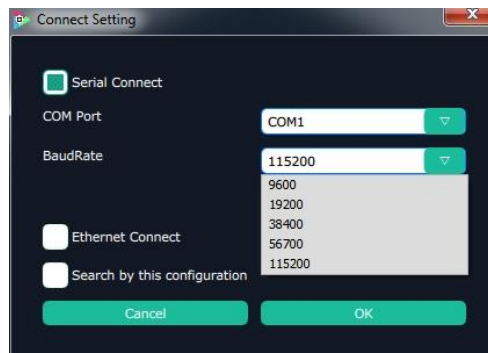

Setting the device connecting ways: Serial Connect, Ethernet Connect and Search by this configuration. After setting "COM Port" and "Baud Rate", pop-up window as follows:

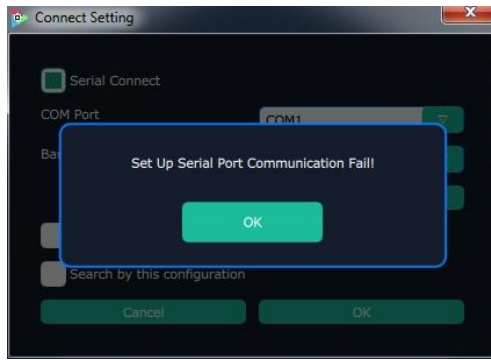

2. IP Settings

Click the "IP Settings", and pop-up window as follows:

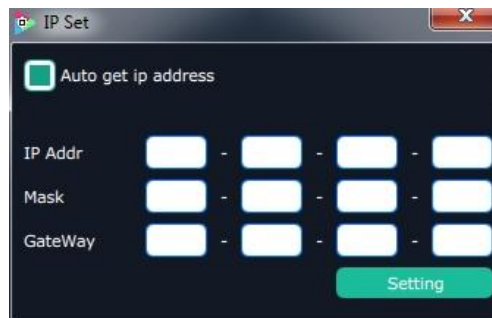

Default "Auto get IP address". Users can also set IP address, Mask and GateWay manually. This is usually used if one computer control some devices or remote control. It takes effect after reboot the software if change IP through network.

3. System Information

Click "System Information", and pop-up window as follows:

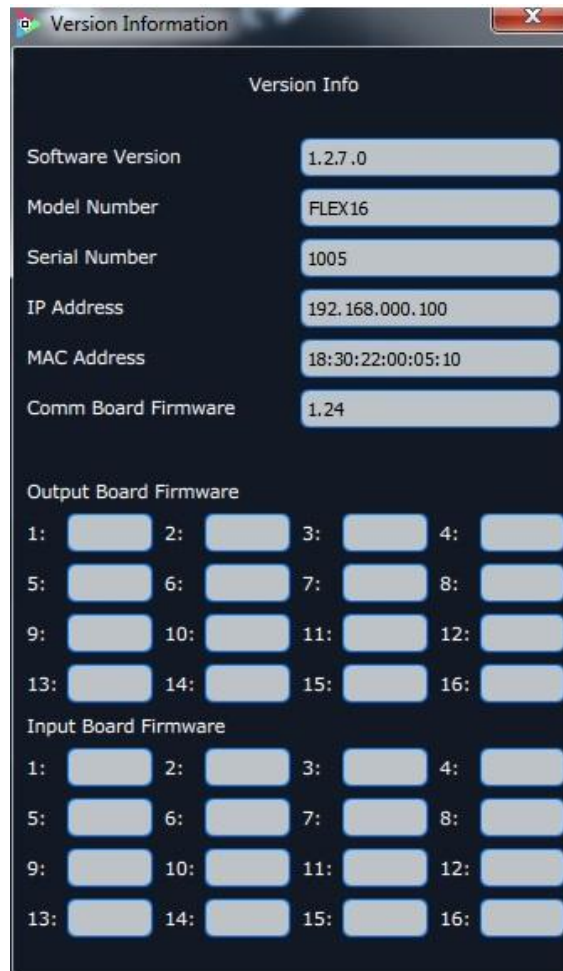

Display the device version information. Including Model Number, Serial Number, IP Address, firmware version, etc.

4. Factory Reset

Click "Factory Reset", and pop-up window as follows:

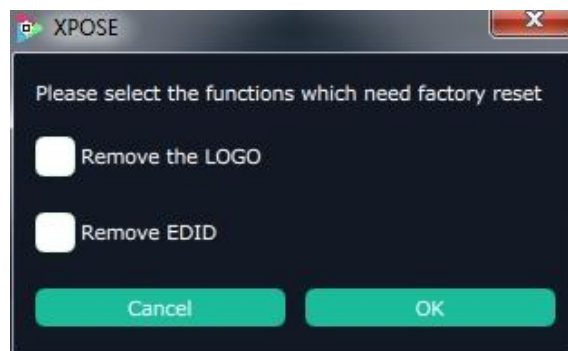

Click "OK" or "Cancel" to confirm the reset.

Access control

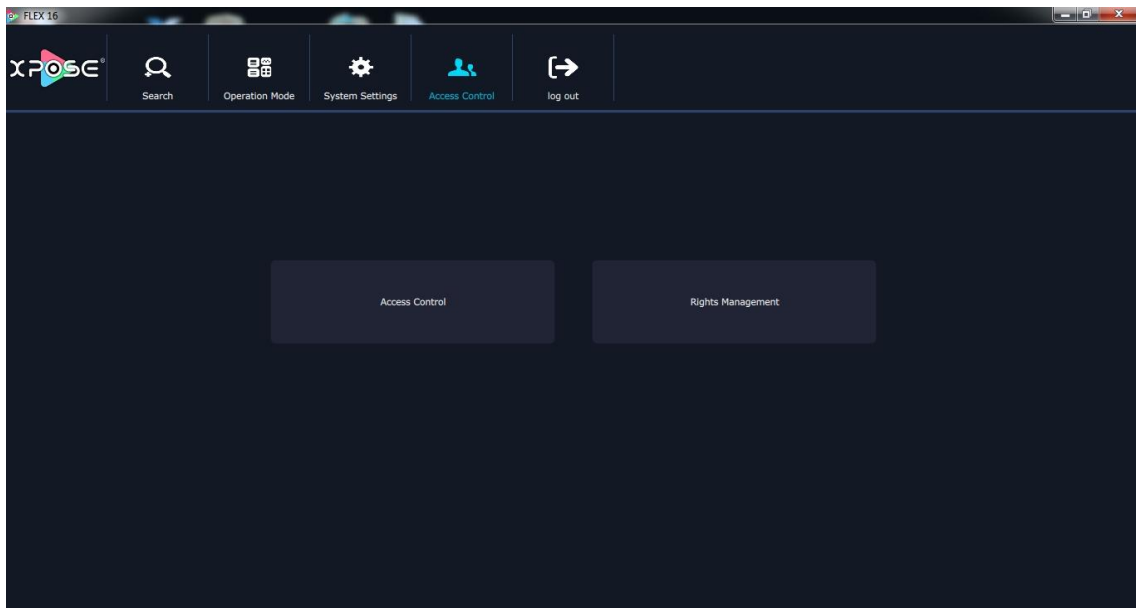

Click “Access control” in the main interface:

Role management and rights management are included in access control, specific as follows:

1. Access Control

Click “Access Control” and pop-up window as follows:

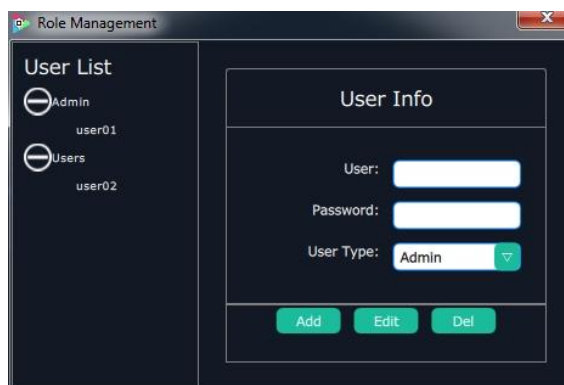

Add: Input the user name and password, and select the user type as “Admin’ or “Users”, click “Add” after setting.

Edit: Select the admin or users in user’s list, then edit the password or user type, click “Edit” after setting.

Del: Select the admin or users in user’s list, then click “Del”, the selected user will be deleted.

2. Rights Management

Click the “Rights Management”, and pop-up window as follows:

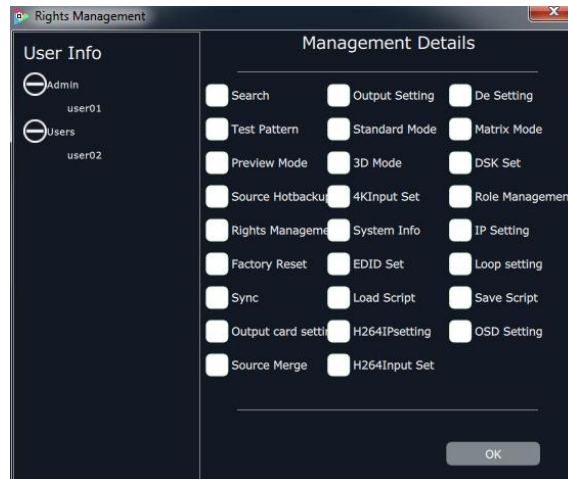

Select the admin or users in user’s list, then click the rights in “Managements Detail”. Click “OK” after setting. User can operate the rights that selected.

User Info: Display all the Admin or Users list, double click it will unfold or fold the list.

Management Details:

The admin can manage all the admin users and users user.

Admin users can manage all the users user, except the admin users.

Users can not mange all the users, including admin user and users user.

Logout

Click “Logout”  to exit the XPOSE software, and pop up window as follows:

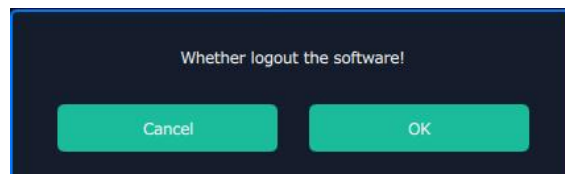

Click “cancel” or “OK” to confirm

User also can be click the right corner  red button to exit software directly.

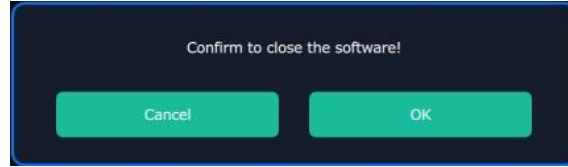

Contact Information

Warranty:

All video products are designed and tested to the highest quality standard and backed by full 3 years parts and labor warranty. Warranties are effective upon delivery date to customer and are non-transferable. RGBlink warranties are only valid to the original purchase/owner. Warranty related repairs include parts and labor, but do not include faults resulting from user negligence, special modification, lighting strikes, abuse(drop/crush), and/or other unusual damages.

The customer shall pay shipping charges when unit is returned for repair.

Head Office:

Room 601A, No. 37-3 Banshang community, Building 3, Xinke Plaza, Torch Hi-Tech Industrial Development Zone, Xiamen, China

PH: +86-592-5771197

Fax: +86-592-5788216

E-mail: Support: support@rgblink.com

Sales: sales@rgblink.com

Web: Support: www.rgblink.com/contact-us

Sales: www.rgblink.com/support