

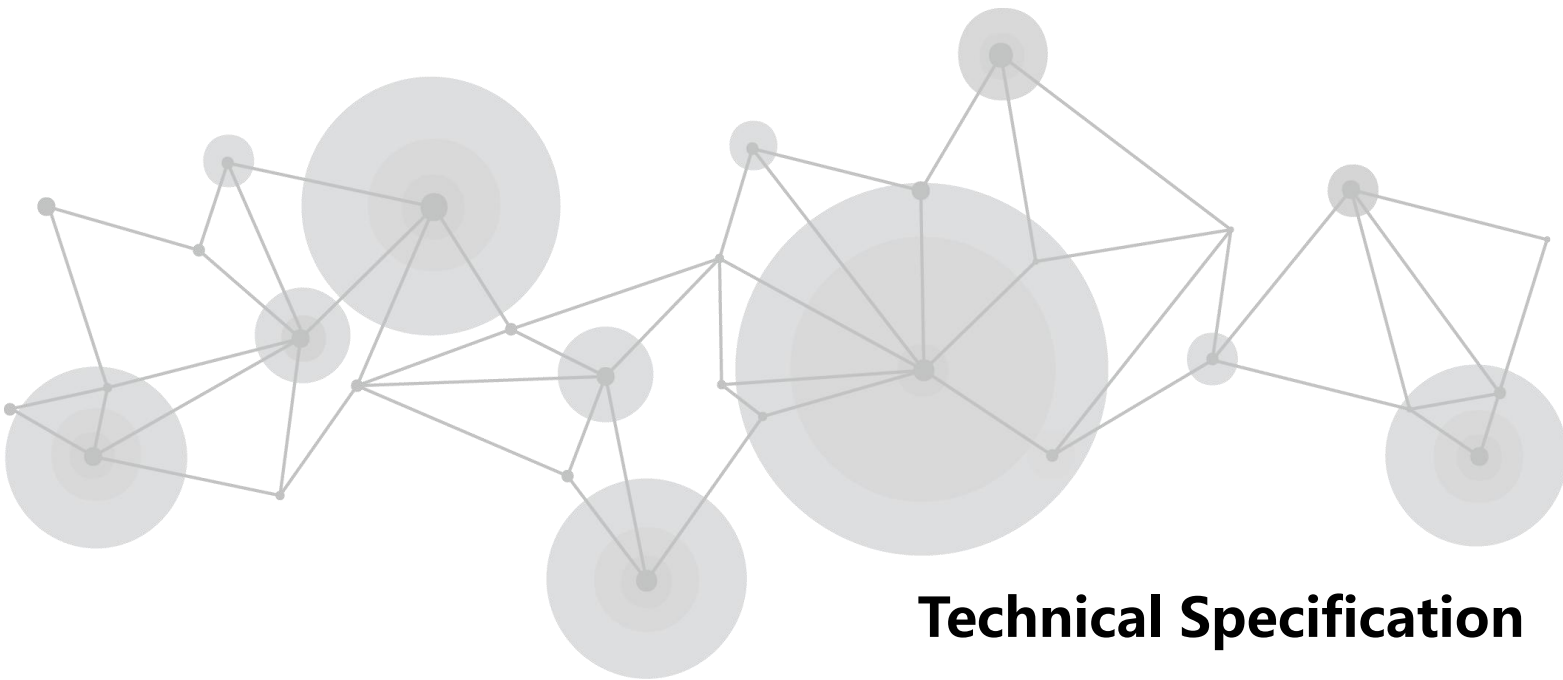

# Q16pro Gen2

## Multi-Window Splicing Processor



**Technical Specification**

## Revision History

Version	Date	Description	Principal
V1.0	2023-03-30	First Release	Aster
V1.1	2023-05-06	Revise order codes	Aster
V1.2	2023-06-15	1. Add input&output module parameters 2. Add notes and cautions	Aster
V1.3	2023-08-17	1. Add 4U net & packaged weights、 module weights、 video source specifications 2. Update dual HDMI 2.0 output module resolution	Aster
V1.4	2023-09-06	Add frame rate & overall bandwidth of HDMI 1.3、 DVI、 HDMI 2.0 input and output modules	Aster
V1.5	2023-12-19	Add optional input and output modules	Aster
V1.6	2023-12-28	Add 1U model	Aster
V1.7	2024-01-12	1. Update 1U rear panel 2. Add specification: dual HDMI 1.3 & dual DVI input module、 dual HDMI 1.3 output module with Dante、 streaming output module、 quad input & quad output analog audio module 3. Add dimension drawing: 8U model、 module	Aster
V1.8	2024-03-13	1. Add 8U model: front panel, rear panel 2. Add specification: quad HDBaseT input module 、 quad HDBaseT output module	Aster
V1.9	2024-04-17	Add single card decoding capability (IP input module)	Aster

## Product Overview

Q16pro Gen2 adopts a high-performance video image processing system with a pure hardware wire-speed processing architecture, which is suitable for education and scientific research, government announcements, information publishing, administrative management, military command, exhibitions, security monitoring, commercial sales and other industries.

The modular input and output card structure is adopted, and the arbitrary mixing function of the input card is realized at the same time. Not only can it easily access the common HDMI/DVI/SDI/IP/AUDIO/DANTE/HDBASET and other multiple signals, but also support DP 1.2, HDMI 2.0 and other ultra-high resolution 4K/8K signal input and output, easily realize 4K multi-screen point-to-point splicing.

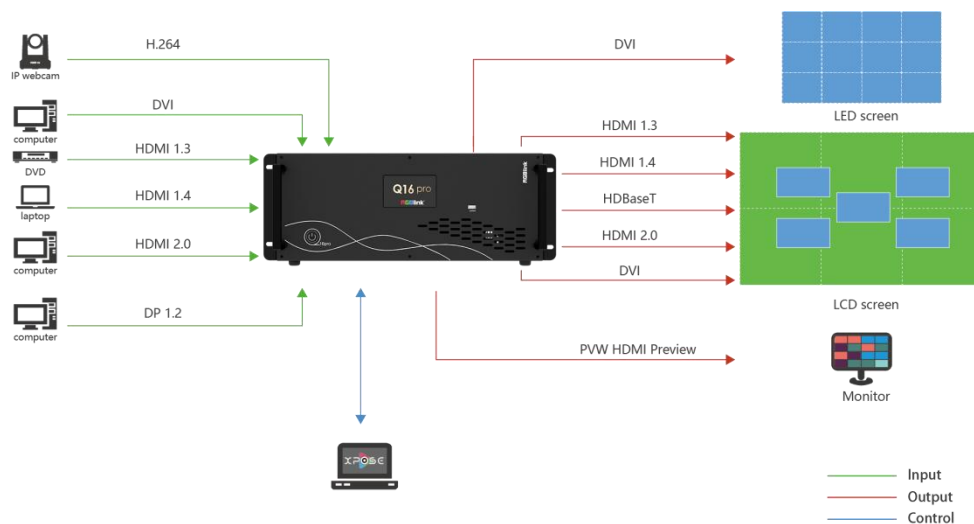

# Features

## Inputs & Outputs

- **7 types of pluggable input modules, user configurable**
  - \* Quad HDMI 1.3 Input Module
  - \* Dual HDMI 2.0 & DP 1.2 Input Module
  - \* Quad 3G SDI (LOOP) Input Module
  - \* Quad DVI Input Module
  - \* Single IP Input Module
  - \* Dual HDMI 1.3 & Dual DVI Input Module
  - \* Quad HDBaseT Input Module
- **Pluggable communication module**
  - \* Communication Module with PVW
- **9 types of pluggable output modules, user configurable**
  - \* Quad HDMI 1.3 Output Module
  - \* Quad 3G SDI Output Module
  - \* Quad DVI Output Module
  - \* Single IP Output Module
  - \* Dual HDMI 2.0 Output Module
  - \* Dual HDMI 1.3 Output Module with Dante
  - \* Streaming Output Module
  - \* Quad HDBaseT Output Module
  - \* Quad Input & Quad Output Analog Audio Module
- **Power module**
  - \* 2U and above support redundant power module

## Key Features

- Each module supports 8 screens spanning the output port without occupying layers
- LOGO overlay
- Dual independent OSD rolling subtitles
- Multi-window monitoring for inputs
- i signal output supported
- 12 bit input and output, RGB 4:4:4 color space
- Seamless switch between signals and scenes
- Dual power module backup

## Device Controls

- **XPOSE Software Control**  
Q16pro Gen2 can be connected to the XPOSE software for smart and convenient device management.
- **Cascading Control via Ethernet**  
The Ethernet control port supports UDP protocol and star topology. Can achieve device cascading and communication on the same LAN.

# Appearance

## Front Panel

1U



Name	Description
Power Button	<ul style="list-style-type: none"> <li>Press the button to power on or power off the device.</li> <li>Button light turns red when powered on.</li> </ul>
LCD Panel	Display current status of the device, and provide interactive choices in conjunction with buttons on the front panel.
Knob	<ul style="list-style-type: none"> <li>Rotate the knob to select a item.</li> <li>Press the knob to confirm the operation.</li> </ul>
Buttons	<ul style="list-style-type: none"> <li>MENU: 1) Enter main menu; 2) Back to the previous menu.</li> <li>SAVE: Push SAVE+Digital Button to save scenes to SCENE1-16.</li> <li>SCALE: Adjust width, height, H position and V position of layers.</li> <li>SPLIT: Select layout for Split Mode.</li> <li>LOAD: Push LOAD+Digital Button to load scenes.</li> <li>LAYOUT: Select layout for Presentation Mode.</li> <li>IN1-IN8: 1) Input signal selection buttons; 2) 1, 2, 3, 4, 6, 7, 8, 9 digital button.</li> <li>L1-L8: 1) Layer selection buttons; 2) L1 and L5 as 5, 0 digital button</li> </ul>
Handles	For carrying device.
Rack Mount Ears	Use with the load-bearing screws to fix device on the rack.

2U



4U

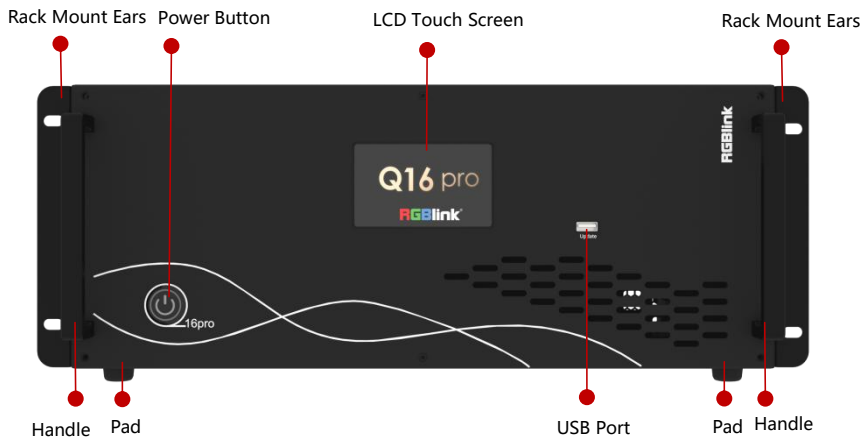

8U

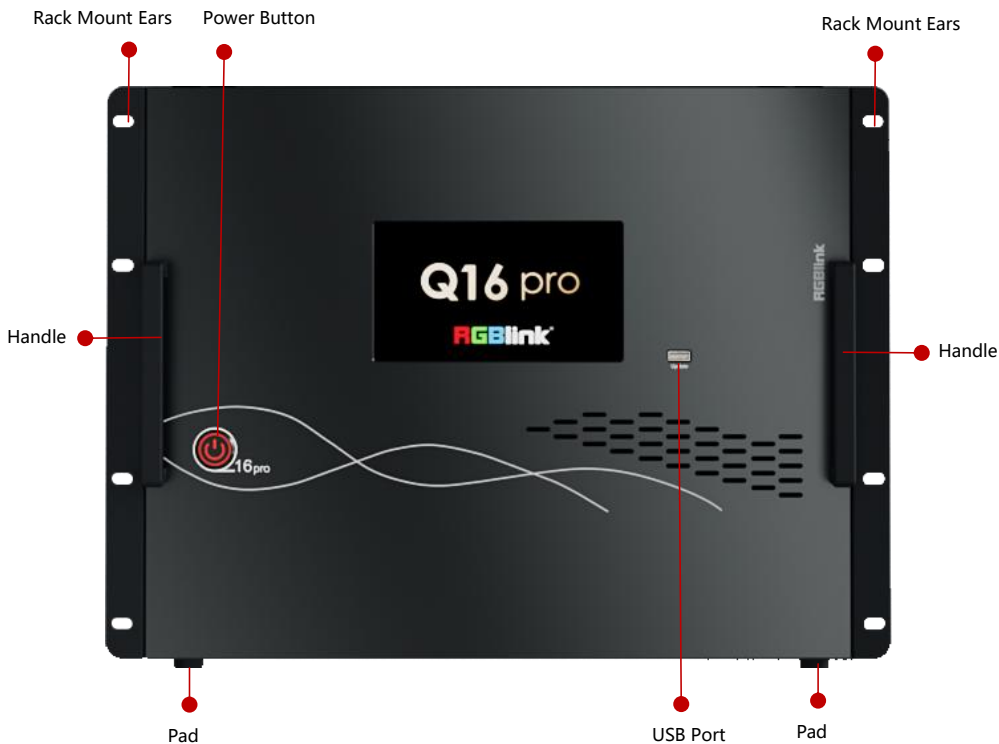

Name	Description
LCD Touch Screen	<ul style="list-style-type: none"> <li>• Display current status of the device.</li> <li>• For menu operation.</li> </ul>
Power Button	<ul style="list-style-type: none"> <li>• Press the button to power on or power off the device.</li> <li>• Button light turns red when powered on.</li> </ul>
USB Port	Used for device upgrade.
Handles	For carrying device.
Rack Mount Ears	Use with the load-bearing screws to fix device on the rack.

## Rear Panel

1U

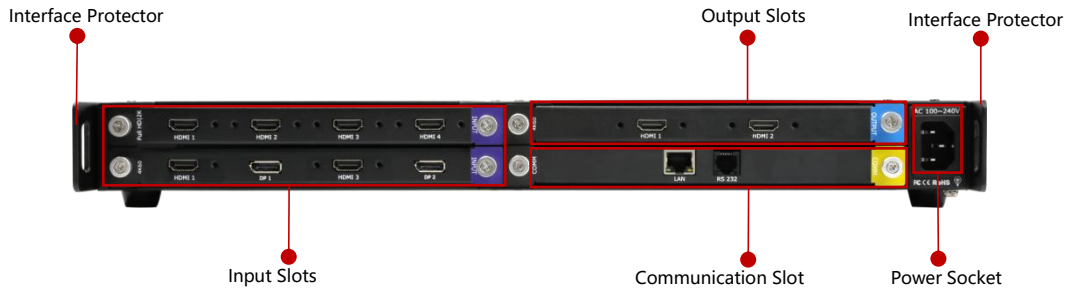

2U

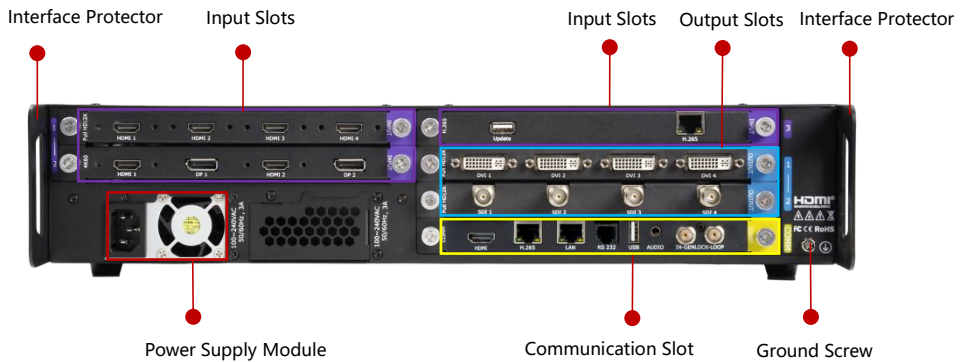

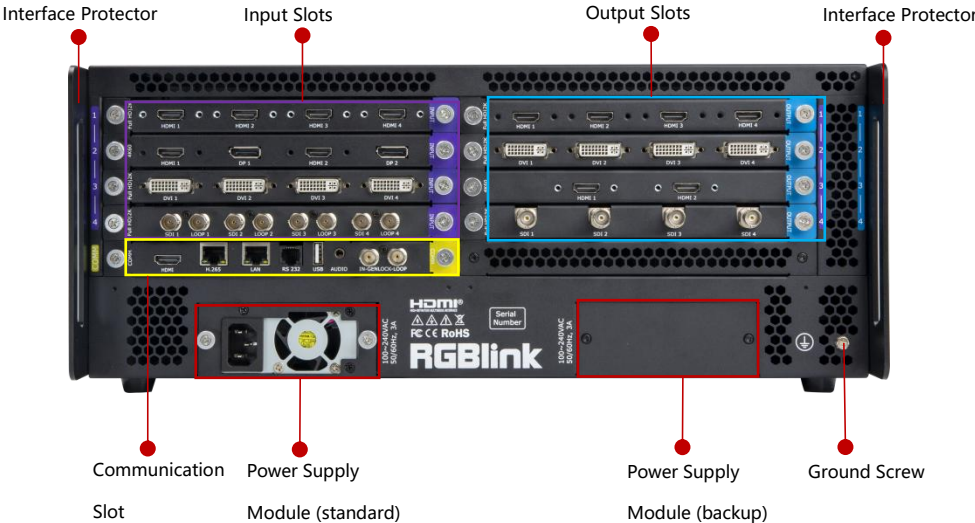

4U

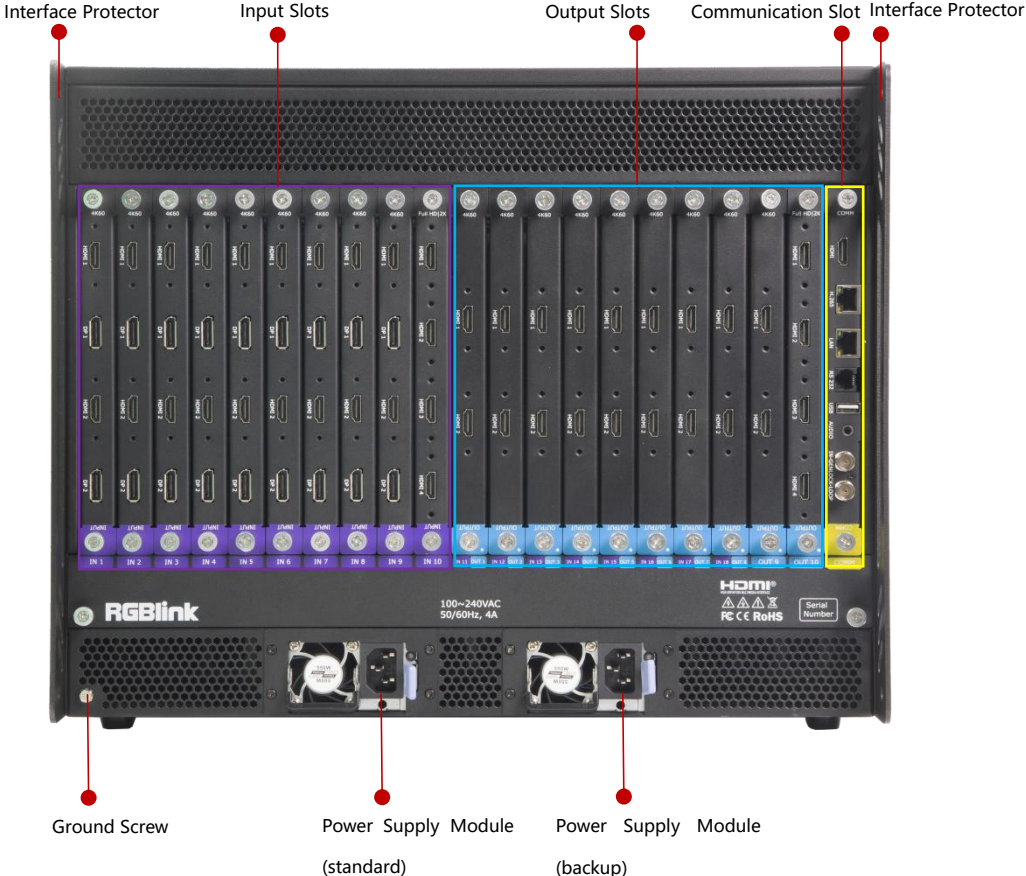

8U







Name	Description
Input Slots	<ul style="list-style-type: none"> <li>Support quad HDMI 1.3, quad DVI, quad 3G SDI (LOOP), dual HDMI 2.0 &amp; DP 1.2, single IP, dual HDMI 1.3 &amp; dual DVI, quad HDBaseT input module</li> <li> purple tip indicates input</li> </ul>
Output Slots	<ul style="list-style-type: none"> <li>Support quad HDMI 1.3, quad 3G SDI, quad DVI, dual HDMI 2.0, single IP, dual HDMI 1.3 with Dante, quad HDBaseT, streaming output module, quad input &amp; quad output analog audio module</li> <li>Support input modules</li> <li> blue tip indicates output</li> </ul>
Communication Module	<ul style="list-style-type: none"> <li>Communication module with PVW</li> <li> yellow tip indicates communication</li> </ul>
Power Module	IEC power socket
Interface Protector	Used to pull out device, fix cables and protect interfaces from collision
Ground Screw	Increase the safety and reliability, and avoid accidents such as fire and explosion caused by static electricity.

## Module Specification

INPUT MODULE		
<b>Input Module 1: Quad HDMI 1.3 Input Module</b>		
		<b>Key Features</b> <ul style="list-style-type: none"> <li>Fully modular architecture</li> <li>Support HDMI (with HDCP) inputs</li> <li>Input resolution up to 2048×1080@60Hz</li> <li>EDID management</li> <li>Support hot swap</li> </ul>
<b>Connectors</b>	<b>Input</b>	4xHDMI-A
<b>Performance</b>	<b>Resolution</b>	<b>SMPTE</b> 720x480p@60   720x576p@50   1280x720p@23.98/24/25/29.97/30/50/59.94/60   1920x1080i@50/59.94/60   1920x1080p@24/25/29.97/30/50/59.94/60   Custom
		<b>VESA</b> 1024x768p@60/75/85   1280x800p@60   1280x1024p@60/75/85   1360x768p@60   1366x768p@60   1440x900p@60   1400x1050p@60   1680x1050p@60   1920x1080p@60   1920x1200p@60   Custom
	<b>Custom Resolutions</b>	1536x960@60   1840x960@60   1920x1152@60   1872x1152@60 Note: Resolutions listed above have been tested already, for other custom resolutions not mentioned, please refer to the actual use.
	<b>Max Width/Height</b>	<ul style="list-style-type: none"> <li>Max width: 2048 (2048x1080@60)</li> <li>Max height: 1200 (1920x1200@60)</li> </ul>
	<b>Frame Rate</b>	120HZ
	<b>Overall Bandwidth</b>	235W
	<b>EDID Management</b>	Support
	<b>HDCP</b>	HDCP 1.X compliant
<b>Physical</b>	<b>Weight</b>	0.27kg
	<b>Dimension</b>	202mm x 190.8mm x 20mm
<b>Order Code</b>	<b>Product Code</b>	790-1002-01-0

INPUT MODULE		
<b>Input Module 2: Quad DVI Input Module</b>		
		<b>Key Features</b> <ul style="list-style-type: none"> <li>• Fully modular architecture</li> <li>• Quad standard DVI input signals</li> <li>• Input resolution up to 2048×1080@60Hz</li> <li>• EDID management</li> <li>• Support hot swap</li> </ul>
<b>Connectors</b>	<b>Input</b>	4xDVI-I
<b>Performance</b>	<b>Resolution</b>	<b>SMPTE</b> 720x480p@60   720x576p@50   1280x720p@23.98/24/25/29.97/30/50/59.94/60   1920x1080i@50/59.94/60   1920x1080p@24/25/29.97/30/50/59.94/60   Custom
		<b>VESA</b> 1024x768p@60/75/85   1280x800p@60   1280x1024p@60/75/85   1360x768p@60   1366x768p@60   1440x900p@60   1400x1050p@60   1680x1050p@60   1920x1080p@60   1920x1200p@60   Custom
	<b>Custom Resolutions</b>	1536x960@60   1840x960@60   1920x1152@60   1872x1152@60 Note: Resolutions listed above have been tested already, for other custom resolutions not mentioned, please refer to the actual use.
	<b>Max Width/Height</b>	<ul style="list-style-type: none"> <li>• Max width: 2048 (2048x1080@60)</li> <li>• Max height: 1200 (1920x1200@60)</li> </ul>
	<b>Frame Rate</b>	120HZ
	<b>Overall Bandwidth</b>	235W
	<b>EDID Management</b>	Support
	<b>HDCP</b>	HDCP 1.X compliant
<b>Physical</b>	<b>Weight</b>	0.27kg
	<b>Dimension</b>	202mm x 190.8mm x 20mm
<b>Order Code</b>	<b>Product Code</b>	790-1002-05-0

INPUT MODULE		
Input Module 3: Dual HDMI 1.3 & Dual DVI Input Module		
		<p><b>Key Features</b></p> <ul style="list-style-type: none"> <li>• Fully modular architecture</li> <li>• Support HDMI (with HDCP) inputs</li> <li>• Input resolution up to 2048×1080@60Hz</li> <li>• EDID management</li> <li>• Support hot swap</li> </ul>
<b>Connectors</b>	<b>Input</b>	2xHDMI-A   2xDVI-I
<b>Performance</b>	<b>Resolution</b>	<p><b>SMPTE</b></p> <p>720x480p@60   720x576p@50   1280x720p@23.98/24/25/29.97/30/50/59.94/60   1920x1080i@50/59.94/60   1920x1080p@24/25/29.97/30/50/59.94/60   Custom</p>
		<p><b>VESA</b></p> <p>1024x768p@60/75/85   1280x800p@60   1280x1024p@60/75/85   1360x768p@60   1366x768p@60   1440x900p@60   1400x1050p@60   1680x1050p@60   1920x1080p@60   1920x1200p@60   Custom</p>
	<b>Custom Resolutions</b>	<p>1536x960@60   1840x960@60   1920x1152@60   1872x1152@60</p> <p>Note: Resolutions listed above have been tested already, for other custom resolutions not mentioned, please refer to the actual use.</p>
	<b>Max Width/Height</b>	<ul style="list-style-type: none"> <li>• Max width: 2048 (2048x1080@60)</li> <li>• Max height: 1200 (1920x1200@60)</li> </ul>
	<b>Frame Rate</b>	120HZ
	<b>Overall Bandwidth</b>	235W
	<b>EDID Management</b>	Support
	<b>HDCP</b>	HDCP 1.X compliant
<b>Physical</b>	<b>Weight</b>	0.27kg
	<b>Dimension</b>	202mm x 190.8mm x 20mm
<b>Order Code</b>	<b>Product Code</b>	790-1002-07-0

INPUT MODULE		
<b>Input Module 4: Quad 3G SDI (LOOP) Input Module</b>		
		<b>Key Features</b> <ul style="list-style-type: none"> <li>• Fully modular architecture</li> <li>• Input resolution up to 1920×1080@60Hz</li> <li>• Support I/P signal input</li> <li>• Support hot swap</li> </ul>
<b>Connectors</b>	<b>Input</b>	8xBNC (4 IN   4 LOOP)
<b>Performance</b>	<b>Resolution</b>	<b>SMPTE</b> 480i@60   720x480p@60   576i@50   1280x720p@50/59.94/60   1920x1080i@50/59.94/60   1920x1080p@23.98/24/25/29.97/30/50/59.94/60
		<b>VESA</b> 1920x1080p@60
	<b>Standard</b>	<ul style="list-style-type: none"> <li>• Support ST-424 (3G), ST292 (HD) standard video inputs.</li> <li>• Support 3G-Level A/Level B (DS mode).</li> </ul>
	<b>Frame Rate</b>	60HZ
	<b>Overall Bandwidth</b>	207W
	<b>Interlaced Signal Inputs</b>	Support
<b>Physical</b>	<b>Weight</b>	0.40kg
	<b>Dimension</b>	202mm x 190.8mm x 20mm
<b>Order Code</b>	<b>Product Code</b>	790-1002-04-0

INPUT MODULE		
Input Module 5: Dual HDMI 2.0 & DP 1.2 Input Module		
		<p><b>Key Features</b></p> <ul style="list-style-type: none"> <li>• Fully modular architecture</li> <li>• Support HDMI(with HDCP) inputs</li> <li>• Input resolution up to 3840×2160@60Hz</li> <li>• EDID management</li> <li>• Support hot swap</li> <li>• Choose one 4K60 input signal or two 4K30 input signals to use</li> </ul>
<b>Connectors</b>	<b>Input</b>	2xHDMI-A   2xDP
<b>Performance</b>	<b>Resolution</b>	<p><b>SMPTE</b></p> <p>480i@60   720x480p@60   576i@50   720x576p@50   1280x720p@50/59.94/60   1920x1080p@23.98/24/25/29.97/30/50/59.94/60   3840x1080p@30/60   3840x2160p@25/30/50/60   Custom</p> <p><b>VESA</b></p> <p>640x480p@60/75/85   800x600p@60/75/85   1024x768p@60/75/85   1280x800p@60   1280x1024p@60/75/85   1360x768p@60   1366x768p@60   1440x900p@60   1400x1050p@60   1366x768p@60   1680x1050p@60   1920x1080p@60   1920x1200p@60   2048x1152p@60   2560x1440p@60   2560x1600p@60   3840x2160p@25/30/50/60</p>
	<b>Max Width/Height</b>	<ul style="list-style-type: none"> <li>• Max width: 3840</li> <li>• Max height: 2160</li> </ul>
	<b>Frame Rate</b>	120HZ
	<b>Overall Bandwidth</b>	829W
	<b>EDID Management</b>	Support
	<b>HDCP</b>	HDCP 2.2 compliant
	<b>Physical</b>	<b>Weight</b>
	<b>Dimension</b>	202mm x 190.8mm x 20mm
<b>Order Code</b>	<b>Product Code</b>	790-1002-03-0

INPUT MODULE		
Input Module 6: Single IP Input Module		
		<p><b>Key Features</b></p> <ul style="list-style-type: none"> <li>• Fully modular architecture</li> <li>• Max support 16-channel 540p60 decoding</li> <li>• Support RTSP/RTMP network protocol</li> <li>• Support NDI protocol transmission (preliminary)</li> <li>• Support hot swap</li> </ul>
<b>Connectors</b>	<b>Input</b>	1xUSB-A   1xRJ45
<b>Performance</b>	<b>Resolution</b>	<p><b>SMPTE</b></p> <p>720p@30/50/60   1080p@30/50/60   2160p@30/60</p>
	<b>Network Protocol</b>	<ul style="list-style-type: none"> <li>• RTSP</li> <li>• RTMP</li> </ul>
	<b>Decoding Standard</b>	<ul style="list-style-type: none"> <li>• H.265 Main Profile Level 5.1</li> <li>• H.264 Baseline/Main/High Profile Level 5.0</li> </ul>
	<b>Decoding Resolution</b>	<ul style="list-style-type: none"> <li>• 1-channel: 3840x2160@60</li> <li>• 4-channel: 1920x1080@60</li> <li>• 16-channel: 960x540@60</li> </ul>
	<b>Single Card Decoding Capability</b>	<ul style="list-style-type: none"> <li>• 1-channel: 3840x2160@60fps</li> <li>• 4-channel: 3840x2160@30fps   1920x1080@60fps</li> <li>• 16-channel: 1920x1080@30fps</li> </ul>
<b>Physical</b>	<b>Weight</b>	0.28kg
	<b>Dimension</b>	202mm x 190.8mm x 20mm
<b>Order Code</b>	<b>Product Code</b>	790-1002-02-0

**PRELIMINARY**

INPUT MODULE		
<b>Input Module 7: Quad HDBaseT Input Module</b>		
		<b>Key Features</b> <ul style="list-style-type: none"> <li>Fully modular architecture</li> <li>Resolution up to 1920×1080@60</li> <li>Extend up to 100m</li> <li>Uncompressed audio and video transmission</li> <li>Support hot swap</li> </ul>
<b>Connectors</b>	<b>Input</b>	4xRJ45
<b>Performance</b>	<b>Resolution</b>	<b>SMPTE</b> 720p@30/50/60   1080p@30/50/60   2160p@30/60
		<b>VESA</b> 800×600@60   1024×768@60   1280×768@60   1280×1024@60   1600×1200@60   1920×1080@60
	<b>Transmission Rate</b>	20Gbps (max)
	<b>Transmission Cable Length</b>	100m
<b>Physical</b>	<b>Weight</b>	0.30kg
	<b>Dimension</b>	202mm x 190.8mm x 20mm
<b>Order Code</b>	<b>Product Code</b>	790-1002-08-0



OUTPUT MODULE		
<b>Output Module 1: Quad HDMI 1.3 Output Module</b>		
		<b>Key Features</b> <ul style="list-style-type: none"> <li>• Fully modular architecture</li> <li>• Output resolution up to 2048×1152@60Hz</li> <li>• Support hot swap</li> </ul>
<b>Connectors</b>	<b>Output</b>	4xHDMI-A
<b>Performance</b>	<b>Resolution</b>	<b>SMPTE/VESA</b> 1024x768p@60   1280x720p@50/59.94/60   1280x800p@60   1280x1024p@60   1360x768p@60   1366x768p@60   1400x1050p@60   1440x900p@60   1600x1200p@60   1680x1050p@60   1920x1080p@23.98/24/25/29.97/30/50/ 59.94/60   1920x1200p@60   2560x816p@60   2048x1152p@60   Custom
	<b>Custom Resolutions</b>	1536x960p@60   1840x960p@60   1920x1152p@60   1920x1200p@60   1872x 1152p@60   2048x1152p@60   1536x1536p@60   2048x1080p@60   2304x 1080p@60   2560×960p@60   3840x640p@60   3840x1080p@30   640x3840p @30/50   512x3840p@50   1152x1536p@60  Note: Resolutions listed above have been tested already, for other custom resolutions not mentioned, please refer to the actual use.
	<b>Max Width/Height</b>	<ul style="list-style-type: none"> <li>• Max width: 3840 (3840x640p@60)</li> <li>• Max height: 3840 (640x3840p@50)</li> </ul>
	<b>Frame Rate</b>	120HZ
	<b>Overall Bandwidth</b>	245W
<b>Physical</b>	<b>Weight</b>	0.28kg
	<b>Dimension</b>	202mm x 190.8mm x 20mm
<b>Order Code</b>	<b>Product Code</b>	790-1002-21-0

OUTPUT MODULE		
<b>Output Module 2: Quad DVI Output Module</b>		
		<b>Key Features</b> <ul style="list-style-type: none"> <li>Fully modular architecture</li> <li>Output resolution up to 2048x1152@60Hz</li> <li>Support hot swap</li> </ul>
<b>Connectors</b>	<b>Output</b>	4xDVI-I
<b>Performance</b>	<b>Resolution</b>	<b>SMPTE/VESA</b> 1024x768p@60   1280x720p@50/59.94/60   1280x800p@60   1280x1024p@60   1360x768p@60   1366x768p@60   1400x1050p@60   1440x900p@60   1600x1200p@60   1680x1050p@60   1920x1080p@23.98/24/25/29.97/30/50/59.94/60   1920x1200p@60   2560x816p@60   2048x1152p@60   Custom
	<b>Custom Resolutions</b>	1536x960p@60   1840x960p@60   1920x1152p@60   1920x1200p@60   1872x1152p@60   2048x1152p@60   1536x1536p@60   2048x1080p@60   2304x1080p@60   2560x960p@60   3840x640p@60   3840x1080p@30   640x3840p@30/50   512x3840p@50   1152x1536p@60  Note: Resolutions listed above have been tested already, for other custom resolutions not mentioned, please refer to the actual use.
	<b>Max Width/Height</b>	<ul style="list-style-type: none"> <li>Max width: 3840 (3840x640p@60)</li> <li>Max height: 3840 (640x3840p@50)</li> </ul>
	<b>Frame Rate</b>	120HZ
	<b>Overall Bandwidth</b>	245W
<b>Physical</b>	<b>Weight</b>	0.28kg
	<b>Dimension</b>	202mm x 190.8mm x 20mm
<b>Order Code</b>	<b>Product Code</b>	790-1002-26-0

OUTPUT MODULE		
Output Module 3: Quad 3G SDI Output Module		
		<b>Key Features</b> <ul style="list-style-type: none"> <li>• Fully modular architecture</li> <li>• Output resolution up to 1920x1080@60Hz</li> <li>• Support hot swap</li> </ul>
<b>Connectors</b>	<b>Output</b>	4xBNC
<b>Performance</b>	<b>Resolution</b>	<b>SMPTE</b> 1280x720p@50/59.94/60   1920x1080p@23.98/24/25/29.97/30/50/59.94/60
	<b>Frame Rate</b>	60HZ
	<b>Overall Bandwidth</b>	207W
<b>Physical</b>	<b>Weight</b>	0.34kg
	<b>Dimension</b>	202mm x 190.8mm x 20mm
<b>Order Code</b>	<b>Product Code</b>	790-1002-25-0

OUTPUT MODULE		
<b>Output Module 4: Dual HDMI 2.0 Output Module</b>		
		<b>Key Features</b> <ul style="list-style-type: none"> <li>• Fully modular architecture</li> <li>• Output resolution up to 4096x2160@60Hz</li> <li>• Support hot swap</li> </ul>
<b>Connectors</b>	<b>Output</b>	2xHDMI-A
<b>Performance</b>	<b>Resolution</b>	<b>SMPTE/VESA</b> 1024x768p@60   1280x720p@50/59.94/60   1280x800p@60   1280x1024p@60   1360x768p@60   1400x1050p@60   1440x900p@60   1600x1200p@60   1680x1050p@60   1920x1080p@23.98/24/25/29.97/30/50/59.94/60   1920x1200p@60   2560x816p@60   2048x1152p@60   2560x1440p@60   2560x1600p@60   3840x1080p@30/60   3840x2160p@50/59.94/60   4096x2160p@25/50/59.94/60   Custom
	<b>Custom Resolutions</b>	1024x768@60   1280x720@50/59.94/60   1280x800@60   1280x1024@60   1360x768@60   1400x1050@60   1440x900@60   1600x1200@60   1680x1050@60   1920x1080@23.98/24/25/29.97/30/50/59.94/60   1920x1200@60   2560x816@60   2048x1152@60   2560x1440@60   2560x1600@60   3840x1080@60   3840x2160@50/59.94/60   4096x2160@25/50/59.94/60  Note: Resolutions listed above have been tested already, for other custom resolutions not mentioned, please refer to the actual use.
	<b>Max Width/Height</b>	<ul style="list-style-type: none"> <li>• Max width: 4096 ( 4096x2160p@60 )</li> <li>• Max height: 2160 ( 4096x2160p@60 )</li> </ul>
	<b>Frame Rate</b>	120HZ
	<b>Overall Bandwidth</b>	884W
	<b>Physical</b>	<b>Weight</b>
	<b>Dimension</b>	202mm x 190.8mm x 20mm
<b>Order Code</b>	<b>Product Code</b>	790-1002-23-0

**PRELIMINARY****OUTPUT MODULE****Output Module 5: Quad HDBaseT Output Module**

		<b>Key Features</b> <ul style="list-style-type: none"> <li>Fully modular architecture</li> <li>Resolution up to 1920×1080@60</li> <li>Support cropping,scaling and roaming of 8 layers</li> <li>Extend up to 100m`</li> <li>Support hot swap</li> </ul>
<b>Connectors</b>	<b>Output</b>	4xRJ45
<b>Performance</b>	<b>Resolution</b>	<b>SMPTE</b> 720p@30/50/60   1080p@30/50/60   2160p@30/60
		<b>VESA</b> 800×600@60   1024×768@60   1280×768@60   1280×1024@60   1600×1200@60   1920×1080@60
	<b>Transmission Rate</b>	20Gbps (max)
	<b>Transmission Cable Length</b>	100m
<b>Physical</b>	<b>Weight</b>	0.30kg
	<b>Dimension</b>	202mm x 190.8mm x 20mm
<b>Order Code</b>	<b>Product Code</b>	790-1002-48-0

**PRELIMINARY****OUTPUT MODULE****Output Module 6: Streaming Output Module**

		<b>Key Features</b> <ul style="list-style-type: none"> <li>• Fully modular architecture</li> <li>• Output resolution up to 1920×1080@60Hz</li> <li>• HDMI 1.3 preview</li> <li>• USB 3.0 recording</li> <li>• Streaming via LAN port and USB-C port</li> <li>• Support simultaneous streaming to 2 platforms via RTMP, RTMPS, NDI</li> <li>• Support hot swap</li> </ul>		
		<b>Connectors</b>	<b>Output</b>	1xHDMI-A   1xUSB-A   1xRJ45   1xUSB-C
<b>Performance</b>	<b>Resolution</b>	<b>SMPTE</b> 720p@50/60   1080p@23.98/24.97/50/59.94/60		
		<b>VESA</b> 1024×768@60   1280×720@50/60   1280×768@60   1280×1024@60   1360×768@60   1920×1080@60		
	<b>Video</b>	Video Formats	HDCP 2.2	
		Video Latency	<4 frames	
	<b>Audio</b>	Delay	up to 8 frames	
		Audio Format	USB: Linear PCM, 16 bits/48 kHz, 2 ch	
	<b>Record/Storage</b>	Record Formats	MP4	
		Disk Formats	FAT32(≤32 GB)   exFAT(64GB~2T)	
<b>Supported Standards</b>	USB	3.0		
	H.265	ITU-T H.265/ ISO/IEC 23008-2		
	<b>Frame Rate</b>	60HZ		
<b>Physical</b>	<b>Weight</b>	0.28kg		
	<b>Dimension</b>	202mm x 190.8mm x 20mm		
<b>Order Code</b>	<b>Product Code</b>	790-1002-29-0		

**PRELIMINARY**

**OUTPUT MODULE**

**Output Module 7: Quad Input & Quad Output Analog Audio Module**

		<p><b>Key Features</b></p> <ul style="list-style-type: none"> <li>• Fully modular architecture</li> <li>• Support volume adjustment</li> <li>• Support 4 inputs and 4 outputs</li> <li>• Video and audio switch synchronously</li> <li>• Support audio setting of different banks</li> <li>• Support extra any digital and analog audio</li> <li>• Support hot swap</li> </ul>														
		<table border="1"> <tr> <td rowspan="2"><b>Connectors</b></td> <td><b>Input</b></td> <td>4×3.5mm audio jack</td> </tr> <tr> <td><b>Output</b></td> <td>4×3.5mm audio jack</td> </tr> <tr> <td><b>Performance</b></td> <td><b>Sound Channel</b></td> <td>Stereo, Double Channels</td> </tr> <tr> <td rowspan="2"><b>Physical</b></td> <td><b>Weight</b></td> <td>0.30kg</td> </tr> <tr> <td><b>Dimension</b></td> <td>202mm x 190.8mm x 20mm</td> </tr> <tr> <td><b>Order Code</b></td> <td><b>Product Code</b></td> <td>790-1002-06-0</td> </tr> </table>	<b>Connectors</b>	<b>Input</b>	4×3.5mm audio jack	<b>Output</b>	4×3.5mm audio jack	<b>Performance</b>	<b>Sound Channel</b>	Stereo, Double Channels	<b>Physical</b>	<b>Weight</b>	0.30kg	<b>Dimension</b>	202mm x 190.8mm x 20mm	<b>Order Code</b>
<b>Connectors</b>	<b>Input</b>	4×3.5mm audio jack														
	<b>Output</b>	4×3.5mm audio jack														
<b>Performance</b>	<b>Sound Channel</b>	Stereo, Double Channels														
<b>Physical</b>	<b>Weight</b>	0.30kg														
	<b>Dimension</b>	202mm x 190.8mm x 20mm														
<b>Order Code</b>	<b>Product Code</b>	790-1002-06-0														

OUTPUT MODULE		
Output Module 8: Dual HDMI 1.3 Output Module with Dante		
		<p><b>Key Features</b></p> <ul style="list-style-type: none"> <li>• Fully modular architecture</li> <li>• Dante input and outputs with up to 32 audio channels supported</li> <li>• Output resolution up to 2048×1152@60Hz</li> <li>• Switching between Dante audio and HDMI 1.3 embedded audio</li> <li>• Audio volume adjustment</li> <li>• Audio mixing</li> <li>• Lossless audio transmission with low latency</li> <li>• Support hot swap</li> </ul>
<b>Connectors</b>	<b>Output</b>	2xHDMI-A   2xRJ45
<b>Performance</b>	<b>Resolution</b>	<p><b>SMPTE/VESA</b></p> <p>1024x768p@60   1280x720p@50/59.94/60   1280x800p@60   1280x1024p@60   1360x768p@60   1366x768p@60   1400x1050p@60   1440x900p@60   1600x1200p@60   1680x1050p@60   1920x1080p@23.98/24/25/29.97/30/50/59.94/60   1920x1200p@60   2560x816p@60   2048x1152p@60   Custom</p>
	<b>Custom Resolutions</b>	<p>1536x960p@60   1840x960p@60   1920x1152p@60   1920x1200p@60   1872x1152p@60   2048x1152p@60   1536x1536p@60   2048x1080p@60   2304x1080p@60   2560x960p@60   3840x640p@60   3840x1080p@30   640x3840p@30/50   512x3840p@50   1152x1536p@60</p> <p>Note: Resolutions listed above have been tested already, for other custom resolutions not mentioned, please refer to the actual use.</p>
	<b>Max Width/Height</b>	<ul style="list-style-type: none"> <li>• Max width: 3840 (3840x640p@60)</li> <li>• Max height: 3840 (640x3840p@50)</li> </ul>
	<b>Sampling Rate</b>	48KHZ
	<b>Frame Rate</b>	120HZ
	<b>Overall Bandwidth</b>	245W
	<b>Physical</b>	<b>Weight</b>
	<b>Dimension</b>	202mm x 190.8mm x 20mm
<b>Order Code</b>	<b>Product Code</b>	790-1002-30-0



COMMUNICATION MODULE		
<b>Communication Module: Communication Module with PVW</b>		
		<b>Key Features</b> <ul style="list-style-type: none"> <li>• Fully modular architecture</li> <li>• Support hot swap</li> </ul>
Connectors	Type	Description
	1xPVW (HDMI)	Used for multi-window monitoring
	1xIP (H.265)	Used for remote control and IP echo
	1xLAN	Connected to router or control PC to realize software control
	1xRS232	Connected to router or control PC to realize software control or device upgrade
	1xUSB	Used for device upgrade
	1xTRS	Used for audio monitoring
	1xIN-GENLOCK-LOOP	Connected to a synchronization signal <ul style="list-style-type: none"> <li>• IN: Used to accept the sync signal</li> <li>• LOOP: Used to loop the sync signal</li> </ul>
Physical	Weight	0.30kg
	Dimension	202mm x 190.8mm x 20mm
Order Code	Product Code	790-1002-22-0

## Dimensions

**Dimension of Q16pro Gen2 1U: 490mm x 363.2mm x 55mm**

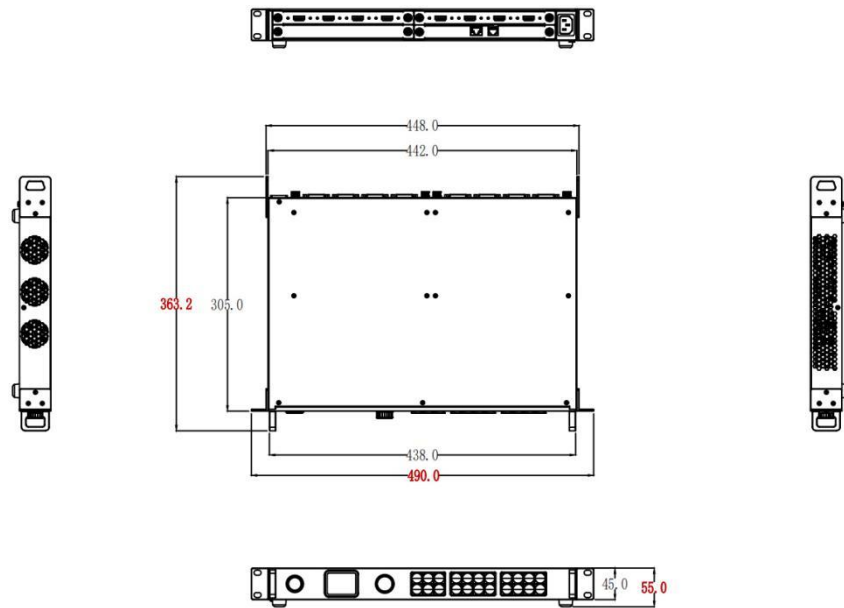

**Dimension of Q16pro Gen2 2U: 483.4mmx377mmx89mm**

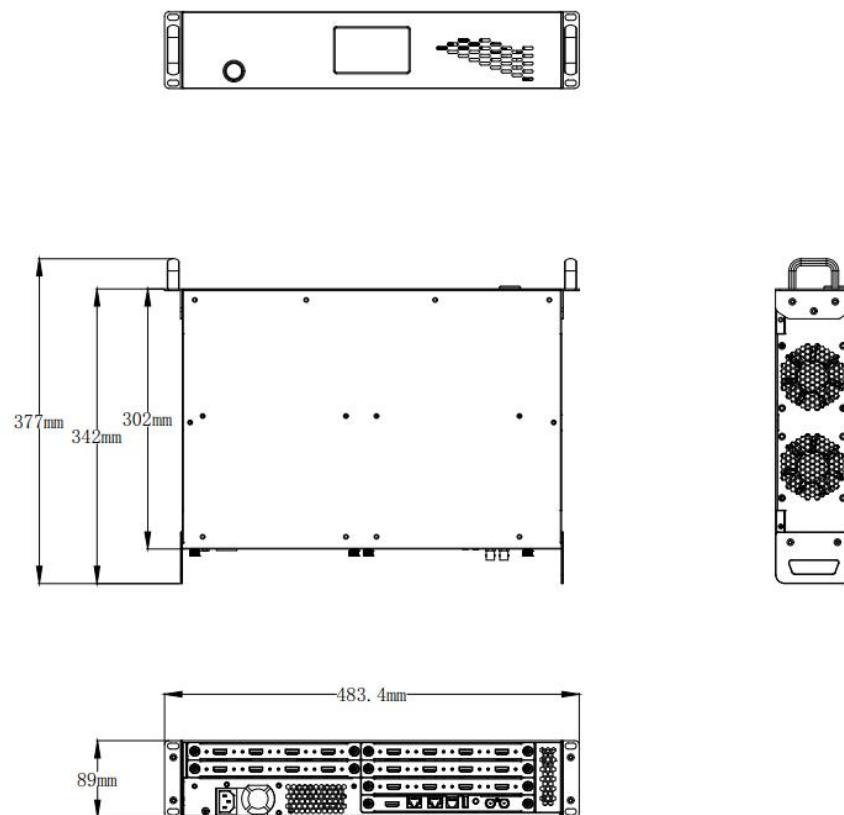

**Dimension of Q16pro Gen2 4U: 483mm x 376mm x 178mm**

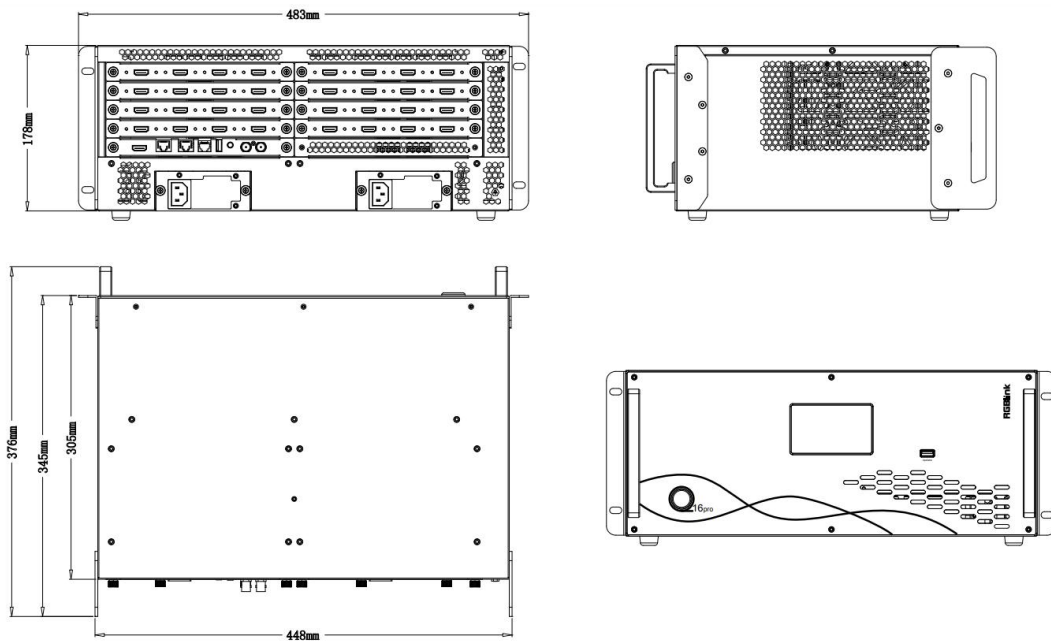

**Dimension of Q16pro Gen2 8U: 488mm x 370mm x 355.6mm**

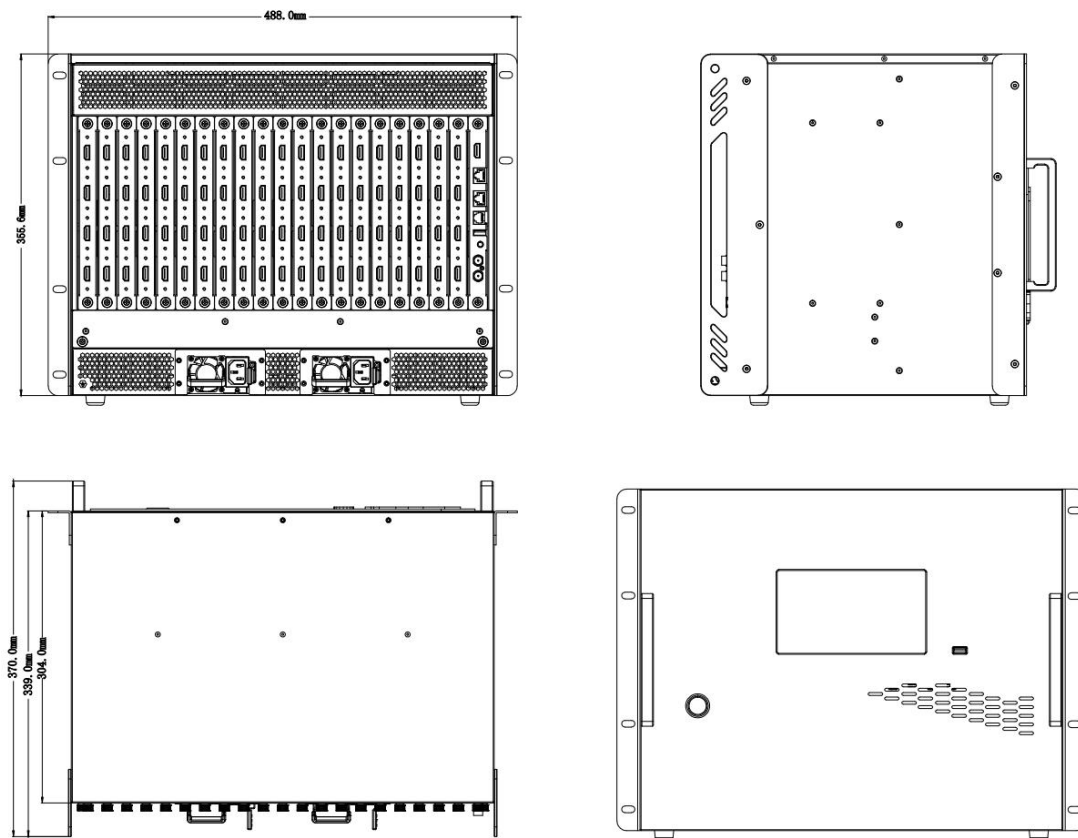

**Dimension of module: 202mm x 190.8mm x 20mm**

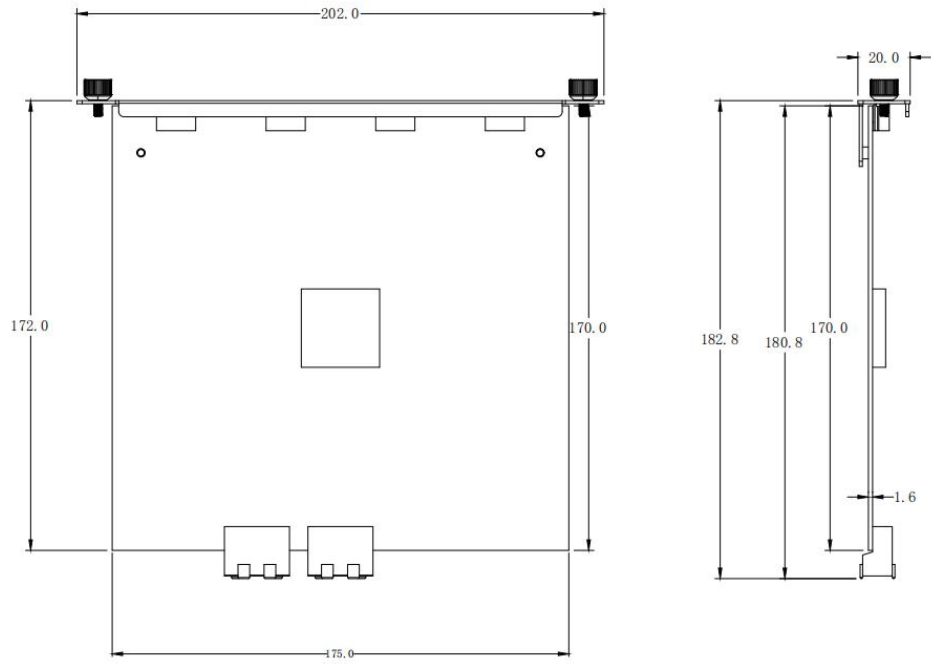

**unit: mm**

# Product Technical Specification

Model		Q16pro Gen2 1U	Q16pro Gen2 2U	Q16pro Gen2 4U	Q16pro Gen2 8U
Specification		1U	2U	4U	8U
Input Slots		2	3	4	10
Output Slots		1	2	4	10
Shared Slots		no support	no support	Output slot No. 1~4	Output slot No. 1~8
Physical	Net Dimension	490x363.2x55mm	483.4x377x89mm	483.4x376x178mm	488x370x355.6mm
	Package Dimension	530x440x120mm	630x585x250mm	645x525x295mm	585x460x520mm
	Net Weight	3.80kg	5.53kg	7.24kg	13.42kg
	Package Weight	5.50kg	9.25kg	11.47kg	18.42kg
	Module	<b>Input Module</b>			
	Weight	Quad HDMI 1.3	0.27kg	Quad DVI	0.27kg
		Dual HDMI 1.3 & Dual DVI	0.27kg	Quad 3G SDI (LOOP)	0.40kg
		Dual HDMI 2.0 & DP 1.2	0.27kg	Single IP	0.26kg
		Quad HDBaseT	0.30kg		
		<b>Output Module</b>			
		Quad HDMI 1.3	0.28kg	Quad DVI	0.28kg
		Quad 3G SDI	0.34kg	Dual HDMI 2.0	0.26kg
		Single IP	0.28kg	Streaming	0.28kg
		Analog Audio Module	0.30kg	Dual HDMI 1.3 with Dante	0.31kg
		Quad HDBaseT	0.30kg		
	<b>Others</b>				
	300W Redundant Power	0.74kg	Communication Module with PVW	0.30kg	
	550W Redundant Power	TBC			
	What's included	1 x USB to RS232 Cable 1 x HDMI to DVI Cable	1 x Network Cable 1 x DVI Cable	1 x RS232 to RJ11 Cable 1 x HDMI Cable	1 x Power Cable
Standards	Supported Standards	SDI	SD/HD/3G		
		HDMI	2.0		
		DVI	1.0		
		DP	1.2		
		H.265	H.265		
		HDBaseT	1.0		
Power	Input Voltage	AC 100V-240V, 50/60Hz (2U and above support dual PSU.)			
Working Environment	Temperature	0°C ~ 45°C			
	Humidity	15%~85%, RH			
Storage Environment	Temperature	0°C ~ 55°C			
	Humidity	5% ~ 85%, RH			

## Video Source Specifications

INPUT		Features		
		Bit Depth	Color Space/Sampling	Input Resolutions
Input Module 1	HDMI 2.0	8bit	RGB4:4:4	3840x2160@60
			YCbCr4:4:4	
			YCbCr4:2:2	
Input Module 2	HDMI 1.3	8bit	RGB4:4:4	1920x1080@60
			YCbCr4:4:4	
			YCbCr4:2:2	
		10bit/12bit	RGB4:4:4	1920x1080@30
			YCbCr4:4:4	
			YCbCr4:2:2	
Input Module 3	DVI	8bit	RGB4:4:4	1920x1080@60
			YCbCr4:4:4	
			YCbCr4:2:2	
		10bit/12bit	RGB4:4:4	1920x1080@30
			YCbCr4:4:4	
			YCbCr4:2:2	
Input Module 4	SDI	10bit	YCbCr4:2:2	1920x1080@60
	Note	<ul style="list-style-type: none"> <li>For requirements of other resolutions, frame rates and bit depths on input module, please contact RGBlink for customization.</li> </ul>		
OUTPUT		Features		
		Bit Depth	Color Space/Sampling	Output Resolutions
Output Module 1	HDMI 1.3	8bit	RGB4:4:4	1920x1080@60
			YCbCr4:4:4	
			YCbCr4:2:2	
		10bit/12bit	RGB4:4:4	1920x1080@30
			YCbCr4:4:4	
			YCbCr4:2:2	

# Notes and Cautions

## Notes for Battery

The general safety information in this summary is for operating personnel.

- **Do Not Remove Covers or Panels** — There are no user-serviceable parts within the unit. Removal of the top cover will expose dangerous voltages. To avoid personal injury, do not remove the top cover. Do not operate the unit without the cover installed.
- **Power Source** — This product is intended to operate from a power source that will not apply more than 230 volts rms between the supply conductors or between both supply conductor and ground. A protective ground connection by way of grounding conductor in the power cord is essential for safe operation.
- **Grounding the Product** — This product is grounded through the grounding conductor of the power cord. To avoid electrical shock, plug the power cord into a properly wired receptacle before connecting to the product input or output terminals. A protective-ground connection by way of the grounding conductor in the power cord is essential for safe operation.
- **Use the Proper Power Cord** — Use only the power cord and connector specified for your product. Use only a power cord that is in good condition. Refer cord and connector changes to qualified service personnel.
- **Use the Proper Fuse** — To avoid fire hazard, use only the fuse having identical type, voltage rating, and current rating characteristics. Refer fuse replacement to qualified service personnel.
- **Do Not Operate in Explosive Atmospheres** — To avoid explosion, do not operate this product in an explosive atmosphere.

## Notes for Installation

When the product needs to be installed on the rack, 4 screws at least M5\*12 should be used to fix it. The rack for installation shall bear at least 42kg weight.

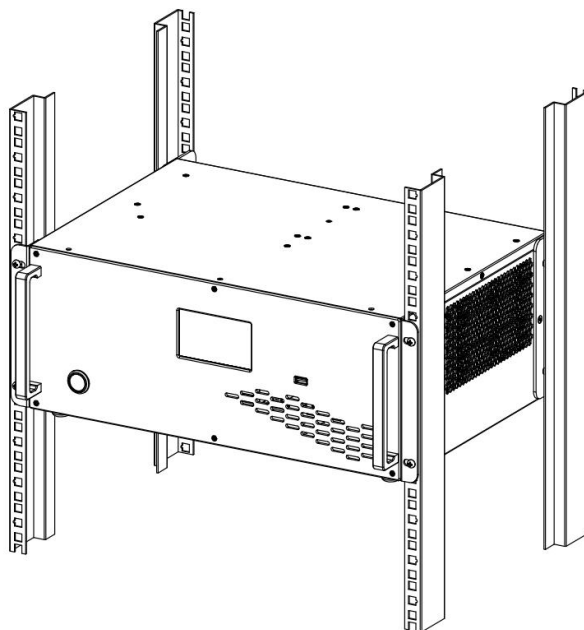

- Safety Precautions — To protect users from electric shock, ensure that the chassis connects to earth via the ground wire provided in the AC power Cord. The AC Socket-outlet should be installed near the equipment and be easily accessible.
- Unpacking and Inspection — Before opening device shipping box, inspect it for damage. If you find any damage, notify the shipping carrier immediately for all claims adjustments. As you open the box, compare its contents against the packing slip. If you find any shortages, contact your sales representative.
- Site Preparation — The environment in which you install your device should be clean, properly lit, free from static, and have adequate power, ventilation, and space for all components.
- Mechanical Loading — Mounting of the device in the rack should be such that a hazardous condition is not achieved due to uneven mechanical loading.



## Order Codes

Product Code	Item
710-1002-10-0	Q16pro Gen2 1U
710-1002-06-1	Q16pro Gen2 2U (Communication Module with PVW Included)
710-1002-01-0	Q16pro Gen2 4U (Communication Module with PVW Included)
710-1002-07-1	Q16pro Gen2 8U (Communication Module with PVW Included)
790-1002-01-0	Q Series Quad HDMI 1.3 Input Module
790-1002-02-0	Q Series Single IP Input Module
790-1002-03-0	Q Series Quad HDMI 2.0 & DP 1.2 Input Module
790-1002-04-0	Q Series Quad 3G SDI (LOOP) Input Module
790-1002-05-0	Q Series Quad DVI Input Module
790-1002-07-0	Q Series Dual HDMI 1.3 & Dual DVI Input Module
790-1002-08-0	Q Series Quad HDBaseT Input Module (preliminary)
790-1002-06-0	Q Series Quad Input & Quad Output Analog Audio Module (preliminary)
790-1002-21-0	Q Series Quad HDMI 1.3 Output Module
790-1002-22-0	Q Series Communication Module with PVW
790-1002-23-0	Q Series Dual HDMI 2.0 Output Module
790-1002-25-0	Q Series Quad 3G SDI Output Module
790-1002-26-0	Q Series Quad DVI Output Module
790-1002-27-0	Q Series Single IP Output Module (preliminary)
790-1002-29-0	Q Series Streaming Output Module (preliminary)
790-1002-30-0	Q Series Dual HDMI 1.3 Output Module with Dante
790-1002-48-0	Q Series Quad HDBaseT Output Module (preliminary)
950-0016-00-0	Q Series 300W Redundant Power Module (for 2U)
950-1004-01-0	Q Series 300W Redundant Power Module (for 4U)
950-0017-00-0	Q Series 550W Redundant Power Module (for 8U)

### Xiamen RGBlink Science & Technology Co Ltd

**Headquarter:** Room 601A, No. 37-3 Banshang community, Building 3, Xinke Plaza, Torch Hi-Tech Industrial Development Zone, Xiamen, China

**Website:** [www.rgblink.com](http://www.rgblink.com) | **Tel:** +86-0592-5771197 | **Fax:** +86-0592-5788216 | **E-mail:** [sales@rgblink.com](mailto:sales@rgblink.com)



©2023 RGBlink All rights reserved.

[www.rgblink.com](http://www.rgblink.com)